

Scilab Textbook Companion for
Electronics Devices And Circuit Theory
by R. L. Boylestad And L. Nashelsky¹

Created by
Shubhanshu Yadav
B.Tech. (pursuing)
Electronics Engineering
IIIT, Allahabad
College Teacher
Neetesh Purohit
Cross-Checked by
Sonanya Tatikola, IIT Bombay

May 20, 2016

¹Funded by a grant from the National Mission on Education through ICT, <http://spoken-tutorial.org/NMEICT-Intro>. This Textbook Companion and Scilab codes written in it can be downloaded from the "Textbook Companion Project" section at the website <http://scilab.in>

Book Description

Title: Electronics Devices And Circuit Theory

Author: R. L. Boylestad And L. Nashelsky

Publisher: Pearson Education India

Edition: 9

Year: 2009

ISBN: 81-317-0314-2

Scilab numbering policy used in this document and the relation to the above book.

Exa Example (Solved example)

Eqn Equation (Particular equation of the above book)

AP Appendix to Example(Scilab Code that is an Appednix to a particular Example of the above book)

For example, Exa 3.51 means solved example 3.51 of this book. Sec 2.3 means a scilab code whose theory is explained in Section 2.3 of the book.

Contents

List of Scilab Codes	4
1 Semiconductor Diodes	6
2 Diode Applications	10
3 Bipolar Junction Transistor	40
4 DC Biasing BJT	42
5 BJT AC Analysis	61
6 Field Effect Transistor	88
7 FET Biasing	94
8 FET Amplifiers	126
9 BJT and JFET frequency response	143
10 Operational Amplifiers	163
11 Op Amp Applications	174
12 Power Amplifiers	182
13 Linear Digital ICs	193
14 Feedback and oscillator circuits	196

List of Scilab Codes

Exa 1.1	Thermal Voltage calculation	6
Exa 1.2	Dc level resistance calculation	6
Exa 1.3	Ac resistance calculation	7
Exa 1.4	Zener voltage determination	8
Exa 1.5	Wavelength determination	8
Exa 2.1	Q point using diode characteristics	10
Exa 2.2	Vdq Vr and Idq by approx equivalent model	11
Exa 2.3	Vdq Vr and Idq by ideal diode model	11
Exa 2.4	Vd Vr and Id	11
Exa 2.5	Vd Vr and Id with diode reversed	12
Exa 2.6	Vd Vr and Id for series diode config	12
Exa 2.7	Vo and Id calculation	13
Exa 2.8	Id Vd2 and Vo calculation	13
Exa 2.9	I V1 V2 and Vo calculation	14
Exa 2.10	Vo I1 Id1 and Id2 for parallel diode config	15
Exa 2.11	Resistor values	15
Exa 2.12	Output voltage	16
Exa 2.13	Determine network currents	16
Exa 2.14	Output voltage	17
Exa 2.15	Output voltage for positive logic AND	17
Exa 2.16.a	Sketch output and determine dc level	18
Exa 2.16.b	Sketch output and determine dc level for Si diode case	19
Exa 2.16.c	Determine dc level if Vm is 200V	20
Exa 2.17	Sketch output waveform	20
Exa 2.18	Sketch output waveform	22
Exa 2.19	Sketch output waveform	23
Exa 2.20	Sketch output waveform	25
Exa 2.21	Sketch output waveform using Ge diode	27

Exa 2.22	Sketch output waveform	29
Exa 2.23	Sketch output waveform using Si diode	32
Exa 2.24	Voltages and Power calculation	34
Exa 2.25	Sketch output waveform	35
Exa 2.26.a	V_I V_r I_z P_z	36
Exa 2.26.b	V_I V_r I_z P_z with different R_I	37
Exa 2.27	R_I II Range max power and zener increase	37
Exa 2.28	Range of V_i	38
Exa 3.1	Determining Collector current and V_{be}	40
Exa 3.2	Determining Collector current	41
Exa 4.1	Fixed Bias Network characteristics	42
Exa 4.2	Saturation level	43
Exa 4.3	V_{cc} R_c and R_b for fixed bias config	43
Exa 4.4	Emitter bias Network characteristics	44
Exa 4.6	Saturation current	44
Exa 4.7	V_{ce} and I_c for voltage divider config	45
Exa 4.8	I_{cq} and V_{cq} calculation	45
Exa 4.9	I_{cq} and V_{ceq} calculation	46
Exa 4.10	I_{cq} and V_{ceq} calculation for voltage divider	47
Exa 4.11	I_{cq} and V_{ceq} calculation	48
Exa 4.12	I_{cq} and V_{ceq} calculation for a different beta	48
Exa 4.13	I_b and V_c calculation	49
Exa 4.14	Network characteristics determination	49
Exa 4.15	V_c and V_b calculcation	50
Exa 4.16	V_{ceq} and I_e	50
Exa 4.17	V_{cb} and I_b for common base config	51
Exa 4.18	V_c and V_b calculcation	52
Exa 4.19	V_{cc} R_c and R_b for fixed bias config	52
Exa 4.20	R_1 and R_c	53
Exa 4.21	R_c R_e and R_b	53
Exa 4.22	Resistor values for the netowrk	54
Exa 4.23	R_c R_e R_1 and R_2	55
Exa 4.24	R_b and R_c	55
Exa 4.25	Determine proper operation of network	56
Exa 4.26	Determine proper operation of network	56
Exa 4.27	V_{ce} for voltage divider config	57
Exa 4.28	Stabiliity factor and change in I_c	58
Exa 4.29	Stabiliity factor and change in I_c	58

Exa 4.30	Determine I_{cQ}	59
Exa 5.1	Common base config characteristics	61
Exa 5.2	Z_i A_v and A_i for common emitter	62
Exa 5.3	Common emitter hybrid and common base model	62
Exa 5.4	Network characteristics determination	63
Exa 5.5	Network characteristics determination	64
Exa 5.6	Network characteristics without C_e	65
Exa 5.7	Network characteristics with C_e	66
Exa 5.8	Network characteristics determination	67
Exa 5.9	Network characteristics determination with C_e	68
Exa 5.10	Emitter follower Network characteristics determination	69
Exa 5.11	Network characteristics determination	70
Exa 5.12	Network characteristics determination	71
Exa 5.13	Network characteristics determination	72
Exa 5.14	Fixed Bias Network characteristics	73
Exa 5.15	A_v and A_{vs}	74
Exa 5.16	Network characteristics determination	74
Exa 5.17	Network characteristics determination	75
Exa 5.18	Network characteristics determination	76
Exa 5.19	No load voltage gain	77
Exa 5.20	Dc bias voltage and current	78
Exa 5.21	Input impedance	79
Exa 5.22	Ac current gain	79
Exa 5.23	Output impedance	80
Exa 5.24	Ac voltage gain	80
Exa 5.25	Dc bias voltage and current	80
Exa 5.26	Ac circuit values of Z_i Z_o A_i A_v	81
Exa 5.27	Mirrored Current	82
Exa 5.28	Current through transistors	82
Exa 5.29	Constant current	83
Exa 5.30	Constant current	83
Exa 5.31	Network characteristics determination	83
Exa 5.32	Network characteristics determination	84
Exa 5.33	Determining parameters using hybrid equivalent model	85
Exa 5.34	Determining parameters using hybrid equivalent model	86
Exa 6.1	Sketching the transfer curve	88
Exa 6.2	Sketching the transfer curve	90
Exa 6.3	Sketching the transfer curve	91

Exa 6.4	Sketching the transfer curve and finding value of k . . .	92
Exa 7.1	Network characteristics determination	94
Exa 7.2	Network characteristics determination	95
Exa 7.3	Q point for network	97
Exa 7.4	Network characteristics determination	101
Exa 7.5	Network characteristics determination	102
Exa 7.6	Network characteristics determination	106
Exa 7.7	I_{dq} V_{gsq} and V_{ds} calculation	107
Exa 7.8	I_{dq} V_{gsq} and V_{ds} calculation	110
Exa 7.9	I_{dq} V_{gsq} and V_d calculation	113
Exa 7.10	V_{ds} determination	115
Exa 7.11	I_{dq} V_{dsq} Calculation	117
Exa 7.12	I_{dq} V_{gsq} and V_{ds} calculation	118
Exa 7.13	V_d and V_c level determination	120
Exa 7.14	V_d level determination	120
Exa 7.15	V_{dq} and I_{dq} level	121
Exa 7.16	R_s determination	121
Exa 7.17	V_{dd} and R_d determination	122
Exa 7.18	I_{dq} V_{gsq} and V_{ds} calculation	122
Exa 7.19	Q point value of I_d and V_{gs}	124
Exa 7.20	Q point value of I_d and V_{gs}	124
Exa 8.1	Calculation of g_m for different V_{gs}	126
Exa 8.2	Calculation of g_m for different V_{gs} and max g_m	128
Exa 8.3	g_m vs V_{gs}	129
Exa 8.4	g_m vs I_d	130
Exa 8.5	Output impedance	132
Exa 8.6	FET equivalent model	133
Exa 8.7	JFET fix bias configuration calculation	133
Exa 8.8	JFET self bias configuration calculation	134
Exa 8.9	JFET source follower configuration calculation	135
Exa 8.10	JFET common gate configuration calculation	136
Exa 8.11	Network components determination	137
Exa 8.12	E MOSFET components determination	137
Exa 8.13	R_d value determination	138
Exa 8.14	R_d and R_s determination	139
Exa 8.15	R_d and R_s determination	140
Exa 8.16	Network characteristics determination	141
Exa 8.17	Input output impedance and output voltage	142

Exa 9.1	Log calculation	143
Exa 9.2	Log calculation	143
Exa 9.3	Anti Log calculation	144
Exa 9.4	Log calculation	144
Exa 9.5	Magnitude gain calculation	144
Exa 9.6	Power and voltage gain	144
Exa 9.7	Input power and input voltage	145
Exa 9.8	Break frequency and bode plot	147
Exa 9.9	Frequency aand bode plot	148
Exa 9.10	Frequency and bode plot	150
Exa 9.11	Frequency and bode plot	152
Exa 9.12	Frequency	155
Exa 9.13	Frequency and bode plot	157
Exa 9.14	Frequency	161
Exa 9.15	Fourier transform and time	162
Exa 10.1	Dc voltages and currents calculation	163
Exa 10.2	Single ended output voltage	163
Exa 10.3	Common mode gain	164
Exa 10.4	Common mode gain	164
Exa 10.5	Output voltage	165
Exa 10.6	Output voltage	165
Exa 10.7	Output voltage	166
Exa 10.8	Output offset voltage	167
Exa 10.9	Output offset voltage	167
Exa 10.10	Total offset voltage	167
Exa 10.11	Input bias current	168
Exa 10.12	Cut off frequency	168
Exa 10.13	Maximum closed loop voltage gain	169
Exa 10.14	Maximum frequency	169
Exa 10.15	Current drawn calculation	170
Exa 10.16	Output offset voltage	170
Exa 10.17	Gain and input output impedance calculation	170
Exa 10.18	Cut off frequency	171
Exa 10.19	Maximum frequency	171
Exa 10.20	Open loop voltage gain	172
Exa 10.21	CMRR calculation	172
Exa 10.22	Output voltage	173
Exa 11.1	Output voltage	174

Exa 11.2	Output voltage	174
Exa 11.3	Output voltage	175
Exa 11.4	Output voltage	175
Exa 11.5	Connection of op amp stages	176
Exa 11.6	Output voltage	177
Exa 11.7	Output voltage	178
Exa 11.8	Output voltage	178
Exa 11.10	Il and Vo calculation	179
Exa 11.11	Output voltage	179
Exa 11.12	Cut off frequency	180
Exa 11.13	Cut off frequency of high pass filter	180
Exa 11.14	Cut off frequency of band pass filter	181
Exa 12.1	input output power and efficiency	182
Exa 12.2	Effective Resistance	183
Exa 12.3	Turns ratio	183
Exa 12.4	Ac power delivered	183
Exa 12.5	input and dissipated power and efficiency	184
Exa 12.6	Efficiency calculation	185
Exa 12.7	Input output power and efficiency	186
Exa 12.8	Power and transmission dissipation	186
Exa 12.9	Efficiency calculation	187
Exa 12.10	Input output dissipated power and efficiency	187
Exa 12.11	Dissipated power and efficiency	188
Exa 12.12	Max dissipated power and input voltage	189
Exa 12.13	Harmonic distortion components	189
Exa 12.14	Total Harmonic distortion components	190
Exa 12.15	Second Harmonic distortion	190
Exa 12.16	Total Harmonic distortion and fundamental and total power	191
Exa 12.17	Maximum dissipation	191
Exa 12.18	Max dissipated power	192
Exa 13.1	frequency and output waveform	193
Exa 13.2	Period of output waveform	195
Exa 14.1	input output impedance and voltage gain	196
Exa 14.2	change in gain of feedback amplifier	197
Exa 14.3	gain with and without feedback	197
Exa 14.4	amplifier gain	198
Exa 14.5	voltage gain	198

Exa 14.6	voltage gain	199
Exa 14.7	value of C	199
Exa 14.8	resonant frequency and RC elements	200
Exa 14.9	RC elements for wien bridge	200
Exa 15.1	Measure output and filter voltage	202
Exa 15.2	Voltage regulation value	202
Exa 15.3	Ripple voltage and output voltage value	203
Exa 15.4	Filter dc voltage value	203
Exa 15.5	Ripple of capacitor	204
Exa 15.6	dc voltage across 1k load	204
Exa 15.7	dc ac and ripple values of output signal	204
Exa 15.8	output voltage and zener current	205
Exa 15.9	regulated output voltage	206
Exa 15.10	regulated output voltage	206
Exa 15.11	regulated voltage and circuit current	206
Exa 15.13	minimum input voltage	207
Exa 15.14	max value of load current	207
Exa 15.15	regulated output voltage	208
Exa 15.16	regulated output voltage	208

List of Figures

2.1	Sketch output and determine dc level	18
2.2	Sketch output and determine dc level for Si diode case	19
2.3	Sketch output waveform	21
2.4	Sketch output waveform	23
2.5	Sketch output waveform	24
2.6	Sketch output waveform	26
2.7	Sketch output waveform using Ge diode	28
2.8	Sketch output waveform	30
2.9	Sketch output waveform using Si diode	32
2.10	Sketch output waveform	35
6.1	Sketching the transfer curve	89
6.2	Sketching the transfer curve	90
7.1	Network characteristics determination	95
7.2	Q point for network	97
7.3	Network characteristics determination	100
7.4	Network characteristics determination	103
7.5	Network characteristics determination	105
7.6	I_{dq} V_{gsq} and V_{ds} calculation	108
7.7	I_{dq} V_{gsq} and V_{ds} calculation	111
7.8	I_{dq} V_{gsq} and V_d calculation	113
7.9	I_{dq} V_{dsq} Calculation	116
7.10	I_{dq} V_{gsq} and V_{ds} calculation	118
8.1	Calculation of g_m for different V_{gs}	127
8.2	g_m vs V_{gs}	129
8.3	g_m vs I_d	131

9.1	Break frequency and bode plot	146
9.2	Frequency aand bode plot	148
9.3	Frequency and bode plot	150
9.4	Frequency and bode plot	152
9.5	Frequency and bode plot	156
11.1	Output voltage	176
11.2	Connection of op amp stages	177
11.3	Connection of unity gain ckt	179
13.1	frequency and output waveform	194

Chapter 1

Semiconductor Diodes

Scilab code Exa 1.1 Thermal Voltage calculation

```
1 clear; clc; close;
2
3 t = 273 + 27; //in kelvin
4 t_new = 273 +100;
5 k = 1.38*10^(-23); //in J/K
6 q = 1.6*10^(-19); //C
7
8 Vt = k*t/q;
9 format(10);
10 disp(Vt, 'Thermal voltage for 27 ''C(in V): ');
11
12 Vt = k*t_new/q;
13 disp(Vt, 'Thermal voltage for 100 ''C(in V): ');
```

Scilab code Exa 1.2 Dc level resistance calculation

```
1 clear; clc; close;
2
```

```

3 Id_low = 2; //mA
4 Id_high = 25; //mA
5 Vd_reverse_bias = -10; //V
6
7 Vd_low = 0.5; //V
8 Vd_high = 0.85; //V
9 Id_reverse_bias = -10*10(-6); //A
10
11 Rd_low = Vd_low/Id_low;
12 Rd_high = Vd_high/Id_high;
13 Rd_reverse_bias = Vd_reverse_bias/Id_reverse_bias;
14
15 disp(Rd_low, 'Low level dc resistance(in ohm):');
16 disp(Rd_high, 'High level dc resistance(in ohm):');
17 disp(Rd_reverse_bias, 'Reverse bias dc resistance(in
    ohm):');

```

Scilab code Exa 1.3 Ac resistance calculation

```

1 clear; clc; close;
2
3 Id1 = 2*10(-3); //A
4 Id2 = 25*10(-3); //A
5
6 Delta_Id1 = (4-0)*10(-3); //A
7 Delta_Vd1 = 0.76-0.65; //V
8 rd1 = Delta_Vd1/Delta_Id1;
9
10 Delta_Id2 = (30-20)*10(-3); //A
11 Delta_Vd2 = 0.80-0.78; //V
12 rd2 = Delta_Vd2/Delta_Id2;
13
14 //From graph
15 Vd1 = 0.7; //V
16 Vd2 = 0.79; //V

```



```

17
18 Rd1 = Vd1/Id1;
19 Rd2 = Vd2/Id2;
20
21 disp(rd1,'ac resistance in part a(in ohm) is : ');
22 disp(rd2,'ac resistance in part b(in ohm) is : ');
23 disp(Rd1,'dc resistance in part a(in ohm) is : ');
24 disp(Rd2,'dc resistance in part b(in ohm) is : ');

```

Scilab code Exa 1.4 Zener voltage determination

```

1 clear; clc; close;
2
3 Tc = 0.072; // %/'C
4 Vz = 10; //V
5 T1 = 100; // 'C
6 T0 = 25; // 'C
7
8 Delta_Vz = Tc*Vz*(T1-T0)/100;
9
10 Vz_new = Vz + Delta_Vz;
11
12 disp(Delta_Vz,'Change in zener potential(in V):');
13 disp(Vz_new,'Resulting zener potntial(in V):');

```

Scilab code Exa 1.5 Wavelength determination

```

1 clear; clc; close;
2
3
4 c = 3*10^(17); // nm/s
5 f = 750*10^(12); // Hz
6

```

```
7 Lambda = c/f;
8
9 disp(Lambda, 'Wavelength provided for visible light (
    in nm): ');
```

Chapter 2

Diode Applications

Scilab code Exa 2.1 Q point using diode characteristics

```
1 clear; clc; close;
2
3 E = 10;      // volts
4 R = 500;    // ohms
5
6 Id = E/R;
7 Vd = E;
8
9 Vdq = 0.78; // volts
10 Idq = 18.5*10(-3); // Amperes
11
12 Vr = Idq*R;
13
14 diary('C:\Users\DELL\Desktop\intern\chapter_2\2_1.
      txt');
15 disp(Vdq, 'Voltage at Q-point is :');
16 disp(Idq, 'Current at Q-point is :');
17 disp(Vr, 'Vr = ');
```

Scilab code Exa 2.2 Vdq Vr and Idq by approx equivalent model

```
1 clear; clc; close;
2
3 E = 10;      //volts
4 R = 500;     //ohms
5
6 Vdq = 0.7; //volts
7 Idq = 18.5*10^(-3); //amperes
8
9 diary('C:\Users\DELL\Desktop\intern\chapter_2\2_2.
      txt');
10 disp(Vdq, 'Voltage at Q-point is :');
11 disp(Idq, 'Current at Q-point is :');
```

Scilab code Exa 2.3 Vdq Vr and Idq by ideal diode model

```
1 clear; clc; close;
2
3 E = 10;      //volts
4 R = 500;     //ohms
5
6 Vdq = 0;     //volts
7 Idq = 20*10^(-3); //amperes
8
9 diary('C:\Users\DELL\Desktop\intern\chapter_2\2_3.
      txt');
10 disp(Vdq, 'Voltage at Q-point is :');
11 disp(Idq, 'Current at Q-point is :');
```

Scilab code Exa 2.4 Vd Vr and Id

```
1 clear; clc; close;
```

```

2
3 E = 8;      //volts
4 R = 2.2*10^(3);    //ohms
5
6 Vd = 0.7;    //Diode is on
7 Vr = E-Vd;
8 Id = Vr/R;
9
10 diary('C:\Users\DELL\Desktop\intern\chapter_2\2_4.
      txt');
11 disp(Vd,'Diode Volatge is : ');
12 disp(Vr,'Voltage across R is : ');
13 disp(Id,'Current through diode is : ');

```

Scilab code Exa 2.5 Vd Vr and Id with diode reversed

```

1 clear; clc; close;
2
3 E = 8;      //volts
4 R = 2.2*10^(3);    //ohms
5
6 Id = 0;    //diode reversed
7 Vr = Id*R;
8 Vd = E-Vr;
9
10 diary('C:\Users\DELL\Desktop\intern\chapter_2\2_5.
      txt');
11 disp(Vd,'Diode Volatge is : ');
12 disp(Vr,'Voltage across R is : ');
13 disp(Id,'Current through diode is : ');

```

Scilab code Exa 2.6 Vd Vr and Id for series diode config

```

1 clear; clc; close;
2
3 E = 0.5;      //volts
4 R = 1.2*10^(3); //ohms
5
6 Id = 0;      //diode off
7 Vr = Id*R;
8 Vd = E;
9
10 diary('C:\Users\DELL\Desktop\intern\chapter_2\2_6.
      txt');
11 disp(Vd, 'Diode Volatge is : ');
12 disp(Vr, 'Voltage across R is : ');
13 disp(Id, 'Current through diode is : ');

```

Scilab code Exa 2.7 V_o and I_d calculation

```

1 clear; clc; close;
2
3 E = 12;      //volts
4 Vk1 = 0.7;   //volts
5 Vk2 = 1.8;   //volts
6 R = 0.680*10^(3); //ohms
7
8  $V_o = E - V_{k1} - V_{k2}$ ;
9  $I_d = V_o / R$ ;
10
11 diary('C:\Users\DELL\Desktop\intern\chapter_2\2_7.
      txt');
12 disp( $V_o$ , 'Output Volatge is : ');
13 disp( $I_d$ , 'Output Currp is : ');

```

Scilab code Exa 2.8 I_d V_{d2} and V_o calculation

```

1 clear; clc; close;
2
3 E = 20;      //volts
4 R = 5.6*10^(3); //ohms
5
6 Id = 0;     //amperes
7 Vd1 = 0;
8 Vo = Id*R;
9 Vd2 = E;
10
11
12 diary('C:\Users\DELL\Desktop\intern\chapter_2\2_8.
      txt');
13 disp(Vo, 'Output Volatge is : ');
14 disp(Id, 'Output Current is : ');
15 disp(Vd2, 'Voltage across diode 2 is :')

```

Scilab code Exa 2.9 I V1 V2 and Vo calculation

```

1 clear; clc; close;
2
3 E1 = 10;     //volts
4 E2 = 5;     //volts
5 R1 = 4.7*10^(3); //ohms
6 R2 = 2.2*10^(3); //ohms
7
8 Vd = 0.7;   //volts
9 I = (E1+E2-Vd)/(R1+R2);
10 V1 = I*R1;
11 V2 = I*R2;
12 Vo = V2 - E2;
13
14 diary('C:\Users\DELL\Desktop\intern\chapter_2\2_9.
      txt');
15 disp(Vo, 'Output Volatge is : ');

```

```
16 disp(I, 'Output Current is : ');
17 disp(V1, 'Voltage across resistance 1 is : ');
18 disp(V2, 'Voltage across resistance 2 is : ');
```

Scilab code Exa 2.10 Vo I1 Id1 and Id2 for parallel diode config

```
1 clear; clc; close;
2
3 E = 10; //volts
4 R = 0.33*10^(3); //ohms
5
6 Vo = 0.7; //volts
7 I = (E - Vo)/R;
8 Id1 = I/2;
9 Id2 = I/2;
10
11 diary('C:\Users\DELL\Desktop\intern\chapter_2\2_10.
    txt');
12 disp(Vo, 'Output Volatge is : ');
13 disp(Id1, 'Current through diode 1 is : ');
14 disp(Id2, 'Current through diode 2 is : ');
```

Scilab code Exa 2.11 Resistor values

```
1 clear; clc; close;
2
3 E = 8; //volts
4 Vled = 2; //volts
5 I = 20*10^(-3); //amperes
6
7 R = (E-Vled)/I;
8
9 disp(R, 'resistance value is : ');
```

Scilab code Exa 2.12 Output voltage

```
1
2 clear; clc; close;
3
4 E = 12;      //volts
5 Vd = 0.7;    //volts
6
7 Vo = E - Vd;
8
9 disp(Vo, 'output voltage is : ');
```

Scilab code Exa 2.13 Determine network currents

```
1
2 clear; clc; close;
3
4 E = 20;      //volts
5 Vk1 = 0.7;   //volts
6 Vk2 = 0.7;   //volts
7 R1 = 3.3*10^(3); //ohms
8 R2 = 5.6*10^(3); //ohms
9
10 I1 = Vk1/R1;
11 V2 = E-Vk1-Vk2;
12 I2 = V2/R2;
13
14 Id2 = I2 - I1;
15
16 disp(I1, 'I1 current is : ');
17 disp(I2, 'I2 current is : ');
18 disp(Id2, 'Id2 current is : ');
```

Scilab code Exa 2.14 Output voltage

```
1 clear; clc; close;
2
3 E = 10;      //volts
4 R = 1*10^(3); //ohms
5 Vd1 = 0.7;   //volts
6 Vd2 = 0;     //volts
7
8 Vo = E-Vd1;
9 I = (E-Vd1)/R;
10
11 disp(Vo, 'output voltage is : ');
```

Scilab code Exa 2.15 Output voltage for positive logic AND

```
1 clear; clc; close;
2
3 E = 10;      //volts
4 E1 = 10;     //volts
5 E2 = 0;      //volts
6 R = 1*10^(3); //ohms
7
8 Vd1 = 0;     //volts
9 Vd2 = 0.7;   //volts
10
11 Vo = Vd2;
12
13 disp(Vo, 'output voltage is : ');
```

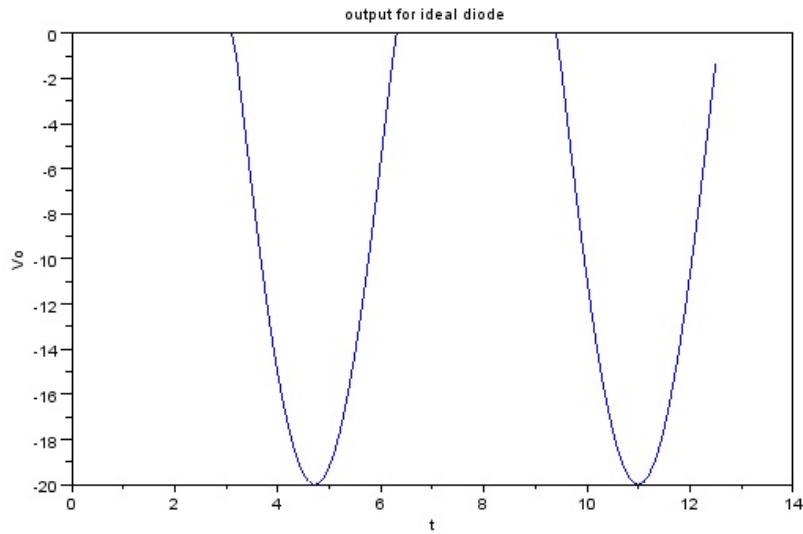

Figure 2.1: Sketch output and determine dc level

Scilab code Exa 2.16.a Sketch output and determine dc level

```

1 clear; clc; close;
2
3 Vm = 20;
4 Vdc = -0.318*Vm;
5
6 disp(Vdc, 'Dc volatge for ideal diode :');
7
8
9 t = 0:0.1:4*%pi;
10 x = 20*sin(t);
11
12 for i=1:length(t)
13     if(x(i)<=0)
14         y(i) = x(i);

```

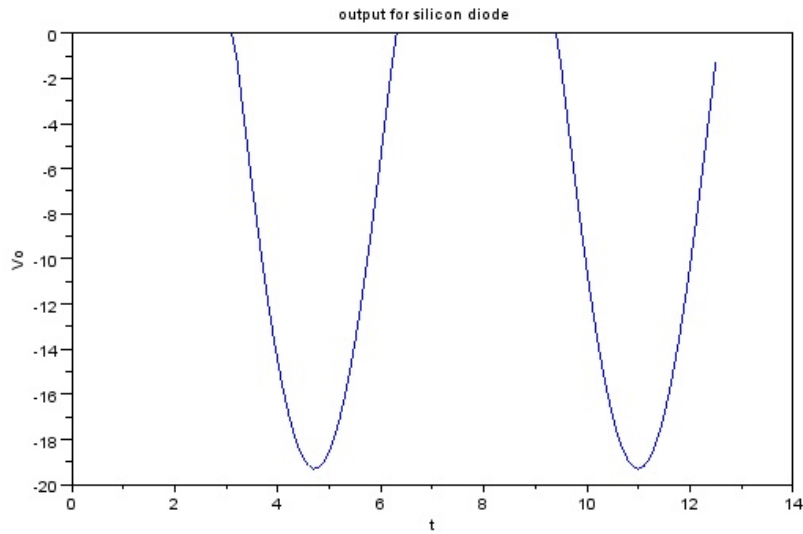

Figure 2.2: Sketch output and determine dc level for Si diode case

```

15     else y(i)=0
16     end
17 end
18
19 plot(t,y)
20 xtitle('output for ideal diode','t','Vo');

```

Scilab code Exa 2.16.b Sketch output and determine dc level for Si diode case

```

1 clear; clc; close;
2
3 Vm = 20; //volts
4 Vdc = -0.318*(Vm-0.7); //volts

```

```

5
6 disp(Vdc, 'Dc voltage for silicon diode :');
7
8
9 t = 0:0.1:4*%pi;
10 x = (20-0.7)*sin(t);
11
12 for i=1:length(t)
13     if(x(i)<=0)
14         y(i) = x(i);
15     else y(i)=0
16     end
17 end
18
19 plot(t,y);
20 xtitle('output for silicon diode', 't', 'Vo');

```

Scilab code Exa 2.16.c Determine dc level if V_m is 200V

```

1 clear; clc; close;
2
3 Vm = 200; // volts
4 Vk = 0.7; // volts
5 Vdc = -0.318*Vm;
6 Vdc_si = -0.318*(Vm - Vk);
7
8 disp(Vdc, 'Dc volatge for ideal diode :');
9 disp(Vdc_si, 'Dc voltage for silicon diode :');

```

Scilab code Exa 2.17 Sketch output waveform

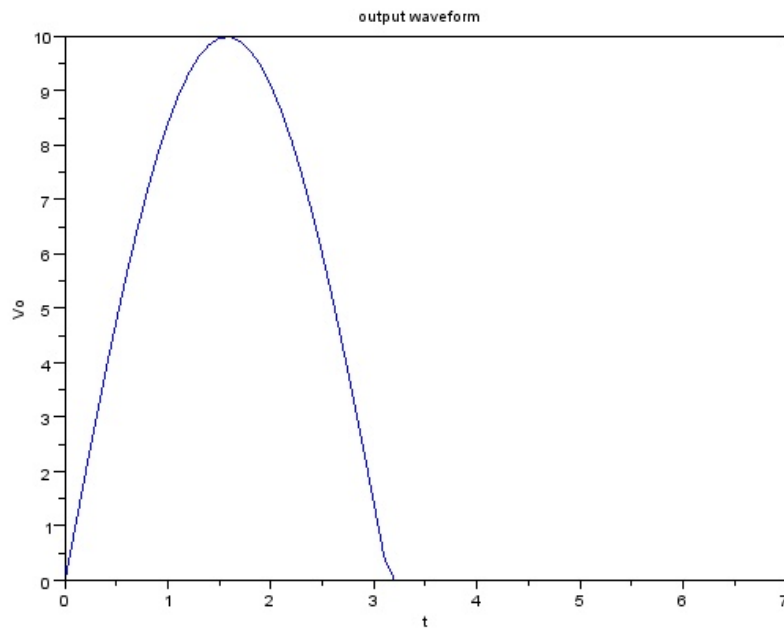

Figure 2.3: Sketch output waveform

```

1 clear; clc; close;
2
3 Vi_max = 10;
4 Vo_max = 0.5*Vi_max;
5
6 Vdc = 0.636*Vo_max;
7
8 disp(Vdc, 'Required Dc voltage :');
9
10 t = 0:0.1:2*%pi;
11 x = 10*sin(t);
12
13 for i=1:length(t)
14     if(x(i)>=0)
15         y(i) = x(i);
16     else y(i)=0;
17     end
18 end
19
20 plot(t,y)
21 xtitle('output waveform','t','Vo');

```

Scilab code Exa 2.18 Sketch output waveform

```

1 clear; clc; close;
2
3 amp = 20;
4 vi_t = -5; //transition voltage
5
6 t = 0:0.1:2*%pi;
7 vi = amp*sin(t);
8 vo = vi+5; //output voltage
9

```

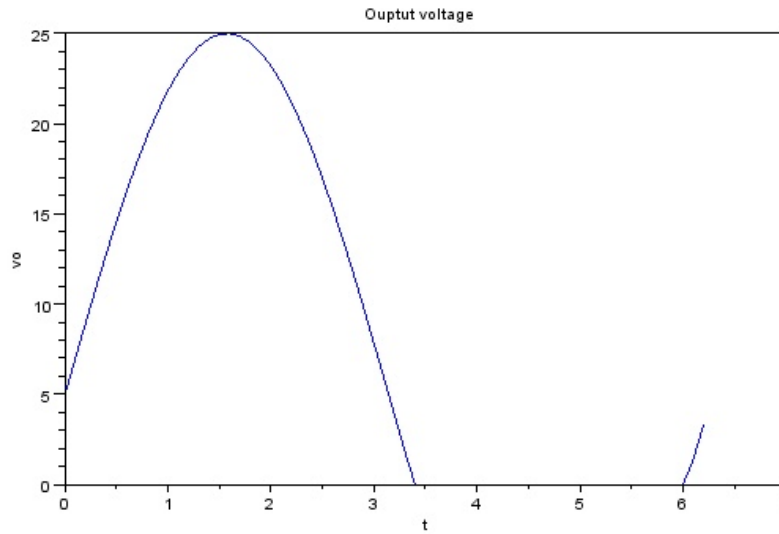

Figure 2.4: Sketch output waveform

```

10 disp(vi_t, 'transition voltage : ');
11
12 for i = 1:length(t)
13     if(vo(i)<=0)
14         vo(i)=0;
15     end
16
17
18 end
19
20 plot(t,vo);
21 xtitle('Ouptut voltage', 't', 'vo');

```

Scilab code Exa 2.19 Sketch output waveform

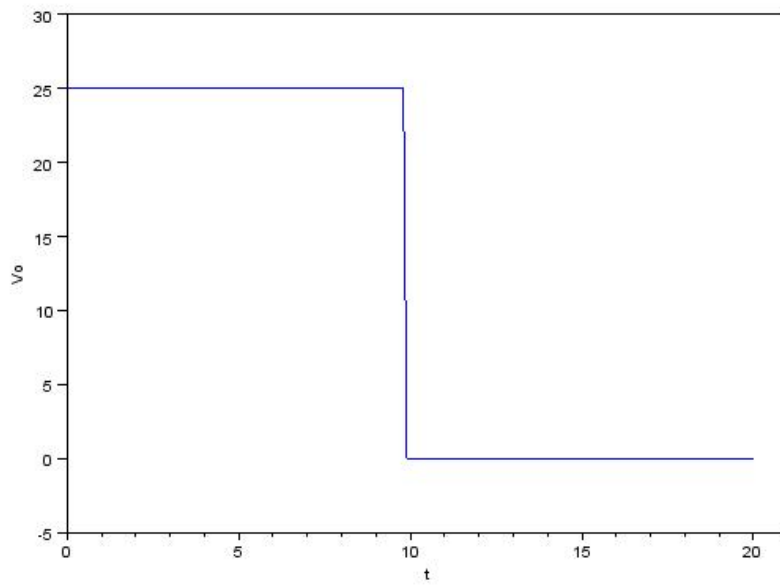

Figure 2.5: Sketch output waveform

```

1 clear; clc; close;
2
3 t = 0:0.1:20;
4 for i=1:int(length(t)/2)
5     vi(i) = 20;
6 end
7 for i = int(length(t)/2):length(t)
8     vi(i) = 0;
9 end
10 for i=1:int(length(t)/2)
11     vo(i) = 20+5;
12 end
13 for i = int(length(t)/2):length(t)
14     vo(i) = 0;
15 end
16 plot2d(t,vo,2,'011','','[0,-5,21,30]);
17 a = gca();
18 a.x_label.text = 't';
19 a.y_label.text = 'Vo';

```

Scilab code Exa 2.20 Sketch output waveform

```

1 clear; clc; close;
2
3 t = 0:0.1:20;
4 for i = 1:length(t);
5     if(t(i)<=5)
6         x(i) = (16/5)*t(i);
7     elseif(t(i)>=5 & t(i)<=16)
8         x(i) = -3.2*t(i) + 32;
9     elseif(t(i)>=16 & t(i)<=20)
10        x(i) = (16/5)*t(i)-64;
11    end

```

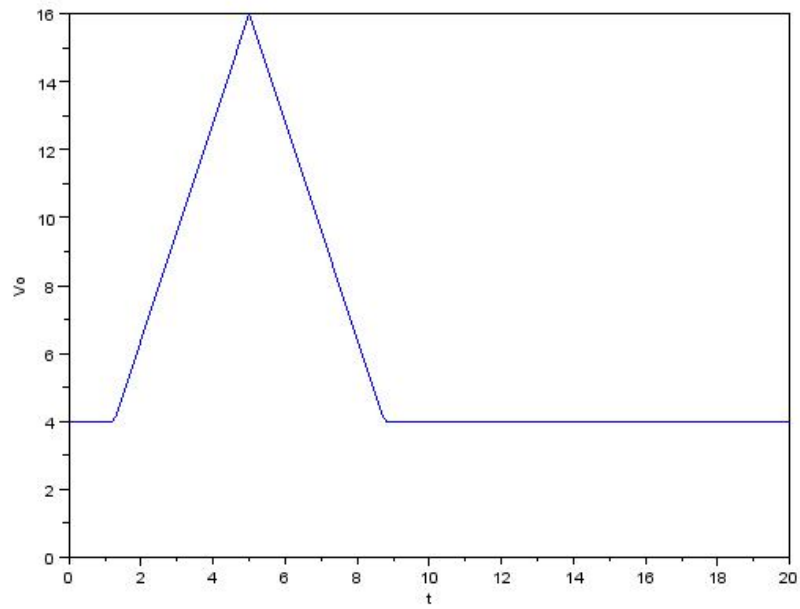

Figure 2.6: Sketch output waveform

```

12 end
13
14 for i = 1:length(t)
15     if(x(i)>4)
16         y(i)=x(i);
17     elseif(x(i)<=4)
18         y(i)=4;
19     end
20 end
21
22 plot2d(t,y,2,'011','',[0,0,20,16]);
23
24 a = gca();
25 a.x_label.text = 't';
26 a.y_label.text = 'Vo';

```

Scilab code Exa 2.21 Sketch output waveform using Ge diode

```

1 clear; clc; close;
2
3 V = 4;
4 Vk = 0.3;
5 id = 0;
6 vd = 0.3;
7
8 vi = V-Vk;
9 disp(vi,'new transition level : ');
10
11 t = 0:0.1:20;
12 for i = 1:length(t);
13     if(t(i)<=5)
14         x(i) = (16/5)*t(i);
15     elseif(t(i)>=5 & t(i)<=16)

```

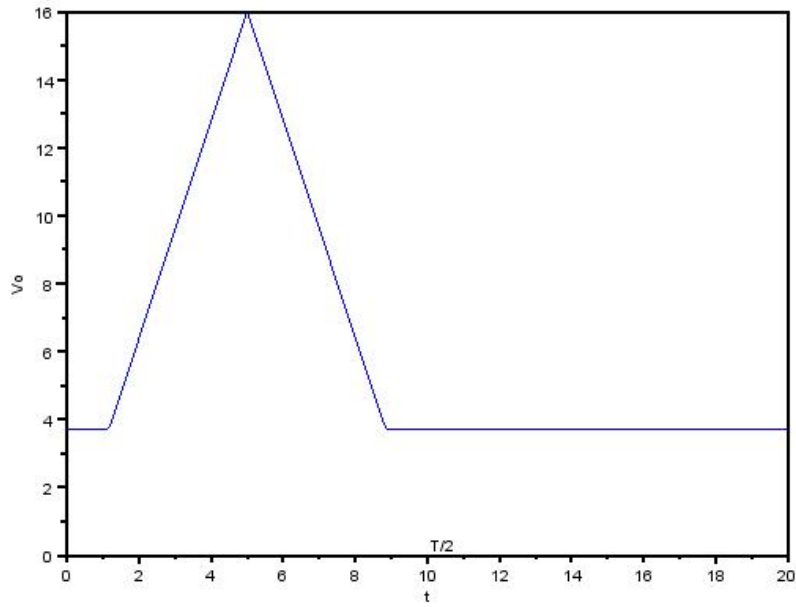

Figure 2.7: Sketch output waveform using Ge diode

```

16         x(i) = -3.2*t(i) + 32;
17     elseif(t(i)>=16 & t(i)<=20)
18         x(i) = (16/5)*t(i)-64;
19     end
20 end
21
22 for i = 1:length(t)
23     if(x(i)>vi)
24         y(i)=x(i);
25     elseif(x(i)<=3.7)
26         y(i)=3.7;
27     end
28 end
29
30 plot2d(t,y,2,'011','',[0,0,20,16]);
31
32 a = gca();
33 a.x_label.text = 't';
34 a.y_label.text = 'Vo';
35
36 xset('thickness',2);
37 xstring(10,0,'T/2');

```

Scilab code Exa 2.22 Sketch output waveform

```

1 clear; clc; close;
2
3 f = 1000;
4 T = 1/f;
5 C = 0.1*10(-6);
6 R = 100*10(3);
7 //between t1—>t2
8 vo_1 = 5;

```

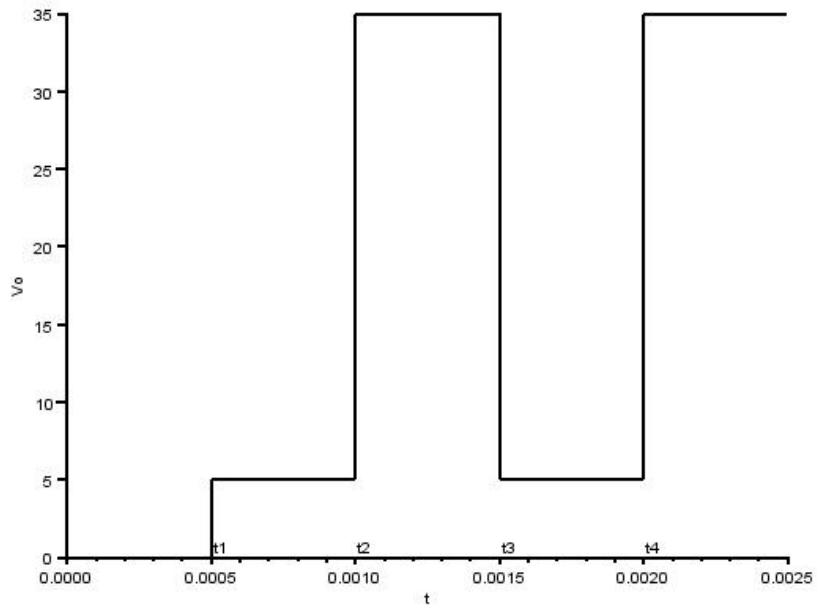

Figure 2.8: Sketch output waveform

```

9 Vc = 25;
10 //between t2—>t3
11 Rth = 0;
12 Eth = 5;
13 vo_2 =35;
14 tau = R*C;
15 discharge_time = 5*tau;
16 //between t3—>t4
17 vo_3 = 5;
18
19 disp(vo_1,'output voltage during t1—>t2 : ');
20 disp(vo_2,'output voltage during t2—>t3 : ');
21 disp(vo_3,'output voltage during t3—>t4 : ');
22
23
24 t = 0:10(-6):2.5*10(-3);
25
26 for i= 1:length(t)
27     if(t(i)>=0 & t(i)<=0.5*10(-3))
28         y(i) = 0;
29     elseif(t(i)>=0.5*10(-3) & t(i)<=10(-3))
30         y(i) = 5;
31     elseif(t(i)>=10(-3) & t(i)<=1.5*10(-3))
32         y(i)=35;
33     elseif(t(i)>=1.5*10(-3) & t(i)<=2.0*10(-3))
34         y(i)=5;
35     elseif(t(i)>=2.0*10(-3) & t(i)<=2.5*10(-3))
36         y(i)=35;
37     end
38 end
39 a = gca();
40 a.thickness = 2;
41 plot2d(t,y);
42 a.x_label.text = 't';
43 a.y_label.text = 'Vo';
44 xset('thickness',2);
45 xstring(0.5*10(-3),0,'t1');
46 xstring(10(-3),0,'t2');

```

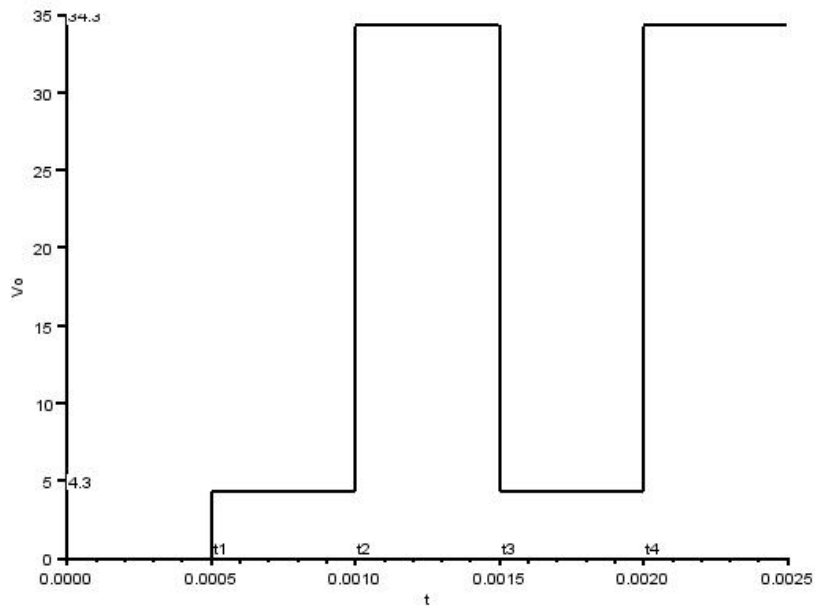



Figure 2.9: Sketch output waveform using Si diode

```
47 xstring(1.5*10(-3),0,'t3 ');
48 xstring(2*10(-3),0,'t4 ');
```

Scilab code Exa 2.23 Sketch output waveform using Si diode

```
1 clear; clc; close;
2
3 f = 1000;
4 T = 1/f;
5 C = 0.1*10(-6);
6 R = 100*10(3);
```

```

7 Vk = 0.7;
8 //between t1→t2
9 vo_1 = 4.3;
10 Vc = 25-0.7;
11 //between t2→t3
12 Rth = 0;
13 Eth = 4.3;
14 vo_2 =34.3;
15 tau = R*C;
16 discharge_time = 5*tau;
17 //between t3→t4
18 vo_3 = 5;
19
20 disp(vo_1, 'output voltage during t1→t2 : ');
21 disp(vo_2, 'output voltage during t2→t3 : ');
22 disp(vo_3, 'output voltage during t3→t4 : ');
23
24
25 t = 0:10(-6):2.5*10(-3);
26
27 for i= 1:length(t)
28     if(t(i)>=0 & t(i)<=0.5*10(-3))
29         y(i) = 0;
30     elseif(t(i)>=0.5*10(-3) & t(i)<=10(-3))
31         y(i) = 4.3;
32     elseif(t(i)>=10(-3) & t(i)<=1.5*10(-3))
33         y(i)=34.3;
34     elseif(t(i)>=1.5*10(-3) & t(i)<=2.0*10(-3))
35         y(i)=4.3;
36     elseif(t(i)>=2.0*10(-3) & t(i)<=2.5*10(-3))
37         y(i)=34.3;
38     end
39 end
40 a = gca();
41 a.thickness = 2;
42 plot2d(t,y);
43 a.x_label.text = 't';
44 a.y_label.text = 'Vo';

```

```

45 xset('thickness',2);
46 xstring(0.5*10(-3),0,'t1');
47 xstring(10(-3),0,'t2');
48 xstring(1.5*10(-3),0,'t3');
49 xstring(2*10(-3),0,'t4');
50 xstring(0,4.3,'4.3');
51 xstring(0,34.3,'34.3');

```

Scilab code Exa 2.24 Voltages and Power calculation

```

1 clear; clc; close;
2
3 E = 40;
4 Vk = 0.7;
5 Vz1 = 6;
6 Vz2 = 3.3;
7 R = 1.3*10(3);
8
9 Vo1 = Vz2 + Vk;
10 Vled =Vo1;
11 Vo2 = Vo1 + Vz1;
12 Vr = E-Vo2-Vled;
13 Ir = Vr/R;
14 Iled = Ir;
15 Iz = Ir;
16 Ps = E*Ir;
17 Pled = Vled*Iled;
18 Pz = Vz1*Iz;
19
20 disp(Vo1,'Reference voltage 1 : ');
21 disp(Vo2,'Reference voltage 2 : ');
22 disp(Iled,'Level of current through led :');
23 disp(Ps,'Power supplied by circuit : ');
24 disp(Pled,'Power absorbed by led :');
25 disp(Pz,'Power absorbed by zener diode :');

```

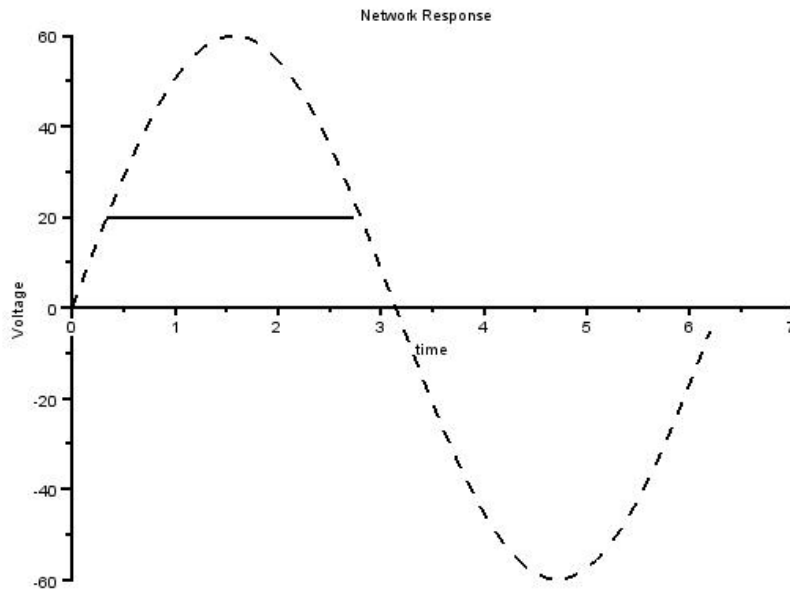

Figure 2.10: Sketch output waveform

Scilab code Exa 2.25 Sketch output waveform

```
1 clear; clc; close;
2
3
4 t = 0:0.1:2*%pi;
5 y = 60*sin(t);
6
7 a = gca();
8 a.line_style = 3;
```

```

 9 a.thickness = 2;
10 a.y_location = 'left';
11 a.x_location = 'middle';
12 a.x_label.text = 'time';
13 a.y_label.text = 'Voltage';
14 a.title.text = 'Network Response';
15 plot2d(t,y);
16
17
18 //a.grid = [1 1];
19
20 t1 = (asin(1/3)):0.1:(%pi-asin(1/3));
21
22 y1 = 20*(t1>=(asin(1/3)))
23
24 b = gca();
25 b.line_style = 1;
26 plot2d(t1,y1);

```

Scilab code Exa 2.26.a V_l V_r I_z P_z

```

1 //Implementation of example 2.26_a in chapter 2
2
3 clear; clc; close;
4
5 R1 = 1.2*10^(3);
6 R = 10^(3);
7 Vi = 16;
8 Vz = 10;
9
10 V = (R1*Vi)/(R+R1);
11 Vl = V;
12 Vr = Vi-Vl;
13 Iz = 0;
14

```

```

15 Pz = Iz*Vz;
16
17 disp(Vl, 'Vl is : ');
18 disp(Vr, 'Vr is : ');
19 disp(Iz, 'IZ is : ');
20 disp(Pz, 'Pz is : ');

```

Scilab code Exa 2.26.b Vl Vr Iz Pz with different Rl

```

1 clear; clc; close;
2
3 Rl = 3*10^(3);
4 R = 10^(3);
5 Vi = 16;
6 Vz = 10;
7
8 V = Vz;
9 Vl = V;
10 Vr = Vi-Vl;
11 Il = Vl/Rl;
12 Ir = Vr/R;
13 Iz = Ir - Il;
14
15
16 Pz = Iz*Vz;
17
18 disp(Vl, 'Vl is : ');
19 disp(Vr, 'Vr is : ');
20 disp(Iz, 'IZ is : ');
21 disp(Pz, 'Pz is : ');

```

Scilab code Exa 2.27 Rl Il Range max power and zener increase

```

1
2 clear; clc; close;
3
4 R = 10^(3);
5 Vz = 10;
6 Vi = 50;
7 Izm = 32*10^(-3);
8 Pz = 380*10^(-3);
9
10 Rlmin = (R*Vz)/(Vi-Vz);
11 Vr = Vi-Vz;
12 Ir = Vr/R;
13 Ilmin = Ir - Izm;
14 Rlmax = Vz/Ilmin;
15 Pmax = Vz*Izm;
16 Izm_2 = Pz/Vz;
17 Ilmin_2 = Ir - Izm_2;
18
19 disp(Rlmin, 'Lowest value of R : ');
20 disp(Rlmax, 'Max value of R : ');
21 disp(Ilmin, 'Min value of I : ');
22 disp(Pmax, 'Maximum wattage rating of diode : ');
23 disp(Ilmin_2, 'New min value of I : ');

```

Scilab code Exa 2.28 Range of Vi

```

1 clear; clc; close;
2
3 R1 = 1200;
4 R = 320;
5 Vz = 20;
6 Izm = 60*10^(-3);
7
8 Vimin = ((R1+R)*Vz)/(R1);
9 Il = Vz/R1;

```

```
10 Imax = Im+Il;  
11 Vmax = Imax*R + Vz;  
12 disp(Vmin, 'Min value of V :');  
13 disp(Vmax, 'Max value of V: ');
```

Chapter 3

Bipolar Junction Transistor

Scilab code Exa 3.1 Determining Collector current and Vbe

```
1 clear; clc; close;
2
3 //part a
4 Ie = 3*10^(-3);
5 Vcb = 10;
6 Ic = Ie;
7 disp(Ic, 'Ic (A): ');
8
9 //part b
10 Vcb = 2;
11 Ie = 3*10^(-3);
12 Ic = Ie;
13 disp(Ic, 'No effect of changing Vcb & Ic remains same
    , Ic(A) is : ');
14 //part c
15 Ic = 4*10^(-3);
16 Vcb = 20;
17 Ie = Ic;
18 Vbe = 0.74;
19 disp(Vbe, 'Vbe(volts) is : ');
20 //part d
```

```
21 Ic = 4*10(-3);
22 Ie = Ic;
23 Vbe = 0.7;
24 disp(Vbe, 'Vbe(volts) in this case is : ');
```

Scilab code Exa 3.2 Determining Collector current

```
1 clear; clc; close;
2
3
4 //part a
5 Ib = 30*10(-6);
6 Vce = 7.5;
7 Ic = 3.3*10(-3);
8 disp(Ic, 'Ic(A) is : ');
9 //part b
10 Vce = 15;
11 Vbe = 0.7;
12 Ib = 20*10(-6);
13 Ic = 2.5*10(-3);
14 disp(Ic, 'Ic(A) ate the intersection of Ib & Vceis : '
    );
15 //part c
16 Ib = 4*10(-6);
17 Vce = 15;
18 Ic = 800*10(-6);
19 disp(Ic, 'Ic(A) in this case is : ');
```

Chapter 4

DC Biasing BJT

Scilab code Exa 4.1 Fixed Bias Network characteristics

```
1 clear; clc; close;
2
3 Vcc = 12;
4 Vbe = 0.7;
5 Vce = 4.23;
6 Rb = 240*10^(3);
7 Rc = 2.2*10^(3);
8 Beta = 75;
9 Ic = 3.53*10^(-3);
10
11 Ibq = (Vcc-Vbe)/Rb;
12 Icq = Beta*Ibq;
13 Vceq = Vcc-Ic*Rc;
14 Vb = Vbe;
15 Vc = Vce;
16 Vbc = Vb-Vc;
17
18 disp(Ibq, 'Ibq (Amperes) is :');
19 disp(Icq, 'Icq (Amperes) is :');
20 disp(Vceq, 'Vceq (volts) is :');
21 disp(Vb, 'Vb (volts) is :');
```

```
22 disp(Vc, 'Vc(volts) is :');
23 disp(Vbc, 'Vbc(volts) is :');
```

Scilab code Exa 4.2 Saturation level

```
1 clear; clc; close;
2
3 Vcc = 12;
4 Rc = 2.2*10^(3);
5
6 Icsat = Vcc/Rc;
7 disp(Icsat, 'saturation current (Amperes) for network
   is :');
```

Scilab code Exa 4.3 Vcc Rc and Rb for fixed bias config

```
1 clear; clc; close;
2
3 Vce = 16;
4 Ic = 10*10^(-3);
5 Vbe = 0.7;
6 Ib = 25*10^(-6);
7
8 Vcc = Vce;
9 Rc = Vcc/Ic;
10 Rb = (Vcc-Vbe)/Ib;
11
12 disp('At Q-point ')
13 disp(Vcc, 'Value of Vcc(Volts) is :');
14 disp(Rc, 'Value of Rc(ohms) is :');
15 disp(Rb, 'Value of Rb(ohms) is :');
```

Scilab code Exa 4.4 Emitter bias Network characteristics

```
1 clear; clc; close;
2
3 Vcc = 16;
4 Vbe = 0.7;
5 Rb = 430*10^(3);
6 Rc = 2*10^(3);
7 Re = 1*10^(3);
8 Beta = 75;
9
10
11 Ib = (Vcc-Vbe)/(Rb+(1+Beta)*Re);
12 Ic = Beta*Ib;
13 Vce = Vcc - Ic*(Rc+Re);
14 Vc = Vcc-Ic*Rc;
15 Ve = Vc - Vce;
16 Vb = Vbe + Ve;
17 Vbc = Vb - Vc;
18
19 disp(Ib, 'Ib (Amperes) is : ');
20 disp(Ic, 'Ic (Amperes) is : ');
21 disp(Vce, 'Vce (volts) is : ');
22 disp(Vc, 'Vc (Volts) is : ');
23 disp(Ve, 'Ve (volts) is : ');
24 disp(Vb, 'Vb (Volts) is : ');
25 disp(Vbc, 'Vbc (Volts) is : ');
```

Scilab code Exa 4.6 Saturation current

```
1 clear; clc; close;
2
```

```

3 Vcc = 16;
4 Rc = 2*10^(3);
5 Re = 1*10^(3);
6
7 Icsat = Vcc/(Rc+Re);
8
9 disp(Icsat, 'Saturation current (amperes) for the
   given network : ');

```

Scilab code Exa 4.7 Vce and Ic for voltage divider config

```

1 clear; clc; close;
2
3 R1 = 39*10^(3);
4 R2 = 3.9*10^(3);
5 Re = 1.5*10^(3);
6 Rc = 4*10^(3);
7 Vcc = 18;
8 Vbe = 0.7;
9 Beta = 140;
10
11 Rth = R1*R2/(R1+R2);
12 Eth = R2*Vcc/(R1+R2);
13 Ib = (Eth - Vbe)/(Rth + (Beta+1)*Re);
14 Ic = Beta*Ib;
15 Vce = Vcc - Ic*(Rc+Re);
16
17 disp(Ic, 'Collector current (Amperes) in :');
18 disp(Vce, 'Vce (Volts) is : ');
19 disp('Value of Vce differs because wrong value of
   Vcc is used in the book');

```

Scilab code Exa 4.8 Icq and Vcq calculation

```

1 clear; clc; close;
2
3 R1 = 39*10^(3);
4 R2 = 3.9*10^(3);
5 Re = 1.5*10^(3);
6 Rc = 4*10^(3);
7 Vcc = 18;
8 Vbe = 0.7;
9 Beta = 140;
10 Ic = 0.63*10^(-3);
11
12 disp('Since the approximate technique can be applied
      ,hence ');
13 Eth = R2*Vcc/(R1+R2);
14 Vb = Eth;
15 Ve = Vb - Vbe;
16 Icq = Ve/Re;
17 Vceq = Vcc - Ic*(Rc+Re);
18
19 disp(Icq, 'Value of Icq (Amperes) is : ');
20 disp(Vceq, 'Value of Vceq (Volts) : ');

```

Scilab code Exa 4.9 Icq and Vceq calculation

```

1 clear; clc; close;
2
3 R1 = 39*10^(3);
4 R2 = 3.9*10^(3);
5 Re = 1.5*10^(3);
6 Rc = 4*10^(3);
7 Vcc = 18;
8 Vbe = 0.7;
9 Beta = 70;
10
11 Rth = R1*R2/(R1+R2);

```

```

12 Eth = R2*Vcc/(R1+R2);
13 Ib = (Eth - Vbe)/(Rth + (Beta+1)*Re);
14 Icq = Beta*Ib;
15 Vceq = Vcc - Icq*(Rc+Re);
16 disp(Icq, 'Collector current (Amperes) in : ');
17 disp(Vceq, 'Vce (Volts) is : ');

```

Scilab code Exa 4.10 Icq and Vceq calculation for voltage divider

```

1 clear; clc; close;
2
3 R1 = 82*10^(3);
4 R2 = 22*10^(3);
5 Re = 1.2*10^(3);
6 Rc = 5.6*10^(3);
7 Vcc = 18;
8 Vbe = 0.7;
9 Beta = 50;
10
11 Rth = R1*R2/(R1+R2);
12 Eth = R2*Vcc/(R1+R2);
13 Ib = (Eth - Vbe)/(Rth + (Beta+1)*Re);
14 Icq = Beta*Ib;
15 Vceq = Vcc - Icq*(Rc+Re);
16 disp(Icq, 'Collector current (Amperes) in : ');
17 disp(Vceq, 'Vce (Volts) is : ');
18
19 //approximate analysis
20 Eth = R2*Vcc/(R1+R2);
21 Vb = Eth;
22 Ve = Vb - Vbe;
23 Icq = Ve/Re;
24 Vceq = Vcc - Icq*(Rc+Re);
25 disp('For approximate analysis : ');
26 disp(Icq, 'Value of Icq (Amperes) is : ');

```



```
27 disp(Vceq, 'Value of Vceq(Volts) : ');
```

Scilab code Exa 4.11 Icq and Vceq calculation

```
1 clear; clc; close;
2
3 Re = 1.2*10^(3);
4 Rc = 4.7*10^(3);
5 Rb = 250*10^(3);
6 Vcc = 10;
7 Vbe = 0.7;
8 Beta = 90;
9
10 Ib = (Vcc - Vbe)/(Rb + (Beta)*(Re+Rc));
11 Icq = Beta*Ib;
12 Vceq = Vcc - Icq*(Rc+Re);
13 disp(Icq, 'Value of Icq(Amperes) is : ');
14 disp(Vceq, 'Value of Vceq(Volts) : ');
```

Scilab code Exa 4.12 Icq and Vceq calculation for a different beta

```
1 clear; clc; close;
2
3 Re = 1.2*10^(3);
4 Rc = 4.7*10^(3);
5 Rb = 250*10^(3);
6 Vcc = 10;
7 Vbe = 0.7;
8 Beta = 135;
9
10 Ib = (Vcc - Vbe)/(Rb + (Beta)*(Re+Rc));
11 Icq = Beta*Ib;
12 Vceq = Vcc - Icq*(Rc+Re);
```

```
13 disp(Icq, 'Value of Icq(Amperes) is : ');
14 disp(Vceq, 'Value of Vceq(Volts) : ');
```

Scilab code Exa 4.13 Ib and Vc calculation

```
1 clear; clc; close;
2
3 Re = 0.51*10^(3);
4 Rc = 3.3*10^(3);
5 Rb = (91+110)*10^(3);
6 Vcc = 18;
7 Vbe = 0.7;
8 Beta = 75;
9
10 Ib = (Vcc - Vbe)/(Rb + (Beta)*(Re+Rc));
11 Ic = Beta*Ib;
12 Vc = Vcc - Ic*(Rc);
13 disp(Ic, 'Value of Icq(Amperes) is : ');
14 disp(Vc, 'Value of Vceq(Volts) : ');
```

Scilab code Exa 4.14 Network characteristics determination

```
1 clear; clc; close;
2
3 Re = 0;
4 Rc = 4.7*10^(3);
5 Rb = 680*10^(3);
6 Vcc = 20;
7 Vbe = 0.7;
8 Beta = 120;
9
10 Ib = (Vcc - Vbe)/(Rb + (Beta)*(Rc));
11 Icq = Beta*Ib;
```

```

12 Vceq = Vcc - Icq*(Rc);
13 Vb = Vbe;
14 Vc = Vceq;
15 Ve = 0;
16 Vbc = Vb-Vc;
17 disp(Icq, 'Value of Icq(Amperes) is : ');
18 disp(Vceq, 'Value of Vceq(Volts) : ');
19 disp(Vc, 'Vc(volts) is : ');
20 disp(Vb, 'Vb(volts) is : ');
21 disp(Ve, 'Ve(volts) is : ');
22 disp(Vbc, 'Vbc(volts) is : ');

```

Scilab code Exa 4.15 Vc and Vb calculation

```

1 clear; clc; close;
2
3 Re = 0;
4 Rc = 1.2*10^(3);
5 Rb = 100*10^(3);
6 Vee = 9;
7 Vbe = 0.7;
8 Beta = 45;
9
10 Ib = (Vee-Vbe)/Rb;
11 Ic = Beta*Ib;
12 Vc = -Ic*Rc;
13 Vb = -Ib*Rb;
14 disp(Vc, 'Vc(Volts) is : ');
15 disp(Vb, 'Vb(Volts) is : ');

```

Scilab code Exa 4.16 Vceq and Ie

```

1 clear; clc; close;

```

```

2
3 Re = 2*10^(3);
4 Rb = 240*10^(3);
5 Vee = 20;
6 Vbe = 0.7;
7 Beta = 90;
8
9 Ib = (Vee-Vbe)/(Rb+(Beta+1)*Re);
10 Ic = Beta*Ib;
11 Ie = (Beta+1)*Ib;
12 Vceq = Vee - (Beta+1)*Ib*Re;
13 disp(Vceq, 'Vceq(Volts) is :');
14 disp(Ie, 'Ie(amperes) is :');

```

Scilab code Exa 4.17 Vcb and Ib for common base config

```

1 clear; clc; close;
2
3 Re = 1.2*10^(3);
4 Rc = 2.4*10^(3);
5 Rb = 240*10^(3);
6 Vee = 4;
7 Vcc = 10;
8 Vbe = 0.7;
9 Beta = 60;
10
11 Ie = (Vee-Vbe)/Re;
12 Ic = Ie;
13 Vcb = Vcc-Ic*Rc;
14 Ib = Ic/Beta;
15 disp(Vcb, 'Vcb(Volts) is : ');
16 disp(Ib, 'Ib(amperes) is : ');

```

Scilab code Exa 4.18 Vc and Vb calculation

```
1 clear; clc; close;
2
3 Re = 1.8*10^(3);
4 Rc = 2.7*10^(3);
5 R1 = 8.2*10^(3);
6 R2 = 2.2*10^(3);
7 Vee = 20;
8 Vcc = 20;
9 Vbe = 0.7;
10 Beta = 120;
11
12 Rth = R1*R2/(R1+R2);
13 I = (Vcc+Vee)/(R1+R2);
14 Eth = I*R2 - Vee;
15 Ib = (Vee-Eth-Vbe)/(Rth+(Beta+1)*Re);
16 Ib = 35.39*10^(-6);
17 Ic = Beta*Ib;
18 Vc = Vcc - Ic*Rc;
19 Vb = Eth+Ib*Rth;
20 disp(Vc, 'Vc (volts) is :');
21 disp(Vb, 'Vb (Volts) is :');
```

Scilab code Exa 4.19 Vcc Rc and Rb for fixed bias config

```
1 clear; clc; close;
2
3 Vcc = 20;
4 Ic = 8*10^(-3);
5 Vbe = 0.7;
6 Ib = 40*10^(-6);
7
8 Rc = Vcc/Ic;
9 Rb = (Vcc-Vbe)/Ib;
```

```
10
11 disp(Rc, 'Rc(ohms) is : ');
12 disp(Rb, 'Rb(ohms) is : ');
```

Scilab code Exa 4.20 R1 and Rc

```
1 clear; clc; close;
2
3 Re = 1.2*10^(3);
4 R2 = 18*10^(3);
5 Vcc = 18;
6 Vce = 10;
7 Vbe = 0.7;
8 Ve = 2.4
9 Ic = 2*10^(-3);
10
11 Ve = Ic*Re;
12 Vb = Vbe+Ve;
13 R1 = (R2*Vcc/Vb) - R2;
14 Vc = Vce+Ve;
15 Rc = (Vcc-Vc)/Ic;
16 disp(R1, 'R1(ohms) is : ');
17 disp(Rc, 'Rc(ohms) is : ');
```

Scilab code Exa 4.21 Rc Re and Rb

```
1 clear; clc; close;
2
3 Icq = 4*10^(-3);
4 Vcc = 28;
5 Vc = 18;
6 Vbe = 0.7;
7 Ve = 2.4;
```

```

8 Beta = 110;
9 Icsat = 8*10(-3);
10
11 Rc = (Vcc-Vc)/Icq;
12 Re = (Vcc/Icsat)-Rc;
13 Ibq = Icq/Beta;
14 Rb = ((Vcc-Vbe)/Ibq) - (Beta+1)*Re;
15
16 disp(Rc, 'Rc(ohms) is : ');
17 disp(Re, 'Re(ohms) is : ');
18 disp(Rb, 'Rb(ohms) is : ');

```

Scilab code Exa 4.22 Resistor values for the netowrk

```

1 clear; clc; close;
2
3 Vcc = 20;
4 Vc = 18;
5 Vce = 10;
6 Vbe = 0.7;
7 Beta = 150;
8 Ic = 2*10(-3);
9 Ie = Ic;
10
11 Ve = 0.1*Vcc;
12 Re = Ve/Ie;
13 Rc = (Vcc-Vce-Ve)/Ic;
14 Ib = Ic/Beta;
15 Rb = (Vcc-Vbe-Ve)/Ib;
16
17 disp(Re, 'Value of Re(ohms) is : ');
18 disp(Rc, 'Value of Rc(ohms) is : ');
19 disp(Rb, 'Value of Rb(ohms) is : ');

```

Scilab code Exa 4.23 Rc Re R1 and R2

```
1 clear; clc; close;
2
3 Vcc = 20;
4 Vc = 18;
5 Vce = 8;
6 Vbe = 0.7;
7 Beta = 150;
8 Ic = 10*10(-3);
9 Ie = Ic;
10 R2 = 1.6*10(3);
11 Ve = 0.1*Vcc;
12 Re = Ve/Ie;
13 Rc = (Vcc-Vce-Ve)/Ic;
14
15 Vb = Vbe + Ve;
16 R1 = R2*Vcc/Vb - R2;
17
18 disp(Re, 'Value of Re(ohms) is : ');
19 disp(Rc, 'Value of Rc(ohms) is : ');
20 disp(R1, 'Value of R1(ohms) is : ');
```

Scilab code Exa 4.24 Rb and Rc

```
1 clear; clc; close;
2
3 Vcc = 10;
4 Vbe = 0.7;
5 Beta_dc = 250;
6 Icsat = 10*10(-3);
7
```



```

8 Rc = Vcc/Icsat;
9 Ib_min = Icsat/Beta_dc;
10 Rb = (Vcc-Vbe)/Ib_min;
11 //if we take standard Rb value then
12 Rb = 150*10^(3);
13 Ib = (Vcc-Vbe)/Rb;
14
15 disp(Rc, 'value of Rc(ohms) is : ');
16 disp(Rb, 'value of Rb(ohms) is : ');

```

Scilab code Exa 4.25 Determine proper operation of network

```

1 clear; clc; close;
2
3 Vcc = 20;
4 Vbe = 0.7;
5 Beta = 100;
6 Rb = 250*10^(3);
7 Re = 2*10^(3);
8 Vrb = 19.85;
9 Ic = 0;
10
11 Irb = Vcc/(Rb+Re);
12 Ib = (Vcc-Vbe)/(Rb+(Beta+1)*Re);
13
14 disp(Irb, 'The base current(amperes) obtained is : ')
15 ;
16 disp(Ib, 'Ideally Ib(Ampere) should be : ');
17 disp('Hence the transistor is in a damaged state, ');
18 disp('with short-circuit between base and emitter. ');
19 ;

```

Scilab code Exa 4.26 Determine proper operation of network

```

1 clear; clc; close;
2
3 Vcc = 20;
4 Vb = 4;
5 Ve = 3.3;
6 Ic = 0;
7 disp('Drop across transistor is : ');
8 disp('This suggests that transistor is in on state.'
      ,Vb-Ve);
9 disp('Ic is : ')
10 disp('This suggest 2 things.',Ic)
11 disp('Either there is poor connection between Rc &
      terminal');
12 disp('or the transistor has an open base-to-
      collector junction.');
```

Scilab code Exa 4.27 Vce for voltage divider config

```

1 clear; clc; close;
2
3 Vcc = -18;
4 Vbe = -0.7;
5 Beta = 100;
6 R1 = 47*10^(3);
7 R2 = 10*10^(3);
8 Re = 1.1*10^(3);
9 Rc = 2.4*10^(3);
10
11 Vb = R2*Vcc/(R1+R2);
12 Ve = Vb-Vbe;
13 Ie = abs(Ve)/Re;
14 Ic = Ie;
15 Vce = Vcc+Ic*(Rc+Re);
16 disp(Vce, 'Vce(volts) is : ');
```

Scilab code Exa 4.28 Stability factor and change in I_c

```
1 clear; clc; close;
2
3 Beta = 50;
4 //denoting Rb/Re by x, we have
5 //for part a
6 x = 250;
7 ico = 19.9*10(-9);
8 s = (1+Beta)*((1+x)/(Beta+1+x));
9 delta_ic = s*ico;
10 disp(s,'stability factor for part a is :');
11 disp(delta_ic,'change in Ic(amperes) is : ');
12
13 //for part b
14 x = 10;
15 s = (1+Beta)*((1+x)/(Beta+1+x));
16 delta_ic = s*ico;
17 disp(s,'stability factor for part b is :');
18 disp(delta_ic,'change in Ic(amperes) is : ');
19
20 //for part c
21 x = 0.01;
22 s = (1+Beta)*((1+x)/(Beta+1+x));
23 delta_ic = s*ico;
24 disp(s,'stability factor for part c is :');
25 disp(delta_ic,'change in Ic(amperes) is : ');
```

Scilab code Exa 4.29 Stability factor and change in I_c

```
1 clear; clc; close;
2
```

```

3 //for part a
4 beta = 100;
5 delta_vbe = -0.17;
6 Rb = 240*10^(3);
7
8 s = -beta/Rb;
9 delta_ic = delta_vbe*s;
10 disp(s,'Stability factor for part a is : ');
11 disp(delta_ic,'change in Ic(amperes) for part a is :
    ');
12
13 //for part b
14 Rb = 240*10^(3);
15 Re = 1*10^(3);
16 s = -beta/(Rb+(beta+1)*Re);
17 delta_ic = delta_vbe*s;
18 disp(s,'Stability factor for part b is : ');
19 disp(delta_ic,'change in Ic(amperes) for part b is :
    ');
20
21 //for part c
22 Rb = 47*10^(3);
23 Re = 4.7*10^(3);
24 s = -1/Re;
25 delta_ic = delta_vbe*s;
26 disp(s,'Stability factor for part c is : ');
27 disp(delta_ic,'change in Ic(amperes) for part c is :
    ');

```

Scilab code Exa 4.30 Determine I_{cQ}

```

1 clear; clc; close;
2
3 //lets say Rb/Re = x, then we have
4 x = 20;

```

```
5 Ic1 = 2*10^(-3);
6 beta1=50;
7 beta2=80;
8
9 s = (Ic1*(1+x))/(beta1*(1+beta2+x));
10 delta_ic = s*(beta2-beta1);
11
12 disp(delta_ic,'change in the level of Ic(amperes) is
    : ')
```

Chapter 5

BJT AC Analysis

Scilab code Exa 5.1 Common base config characteristics

```
1 clear; clc; close;
2
3 Vt=26*(10^(-3)); //thermal voltage=26mV
4 Vi=3*(10^(-3));
5 Ie=4*(10^(-3));; //emitter current=4mV
6 alpha=0.991; //common base amplification factor
7 Rl=610; //Load Resistance(in ohms)
8
9 //Part-1 -> Determining input impedance
10 re = Vt/Ie;
11 disp(re, 'Input impedance(ohms) :');
12
13 //Part-2 -> Calculating the voltage gain
14 Ii = (Vi/re);
15 Ie = Ii;
16 Ic=alpha*Ie;
17 Vo=Ic*Rl;
18 Av = Vo/Vi;
19 disp(Av, "Voltage gain :");
20
21 //Part-3 -> Calculating the output impedance and
```

```

    current gain
22 disp(%inf,"The output impedance(ohms) is :");
23 Ai = -Ic/Ie;
24 disp(Ai,"Current gain is :");

```

Scilab code Exa 5.2 Zi Av and Ai for common emitter

```

1 clear; clc; close;
2
3 Vt=26*(10^(-3)); //thermal voltage
4 Ie=3.2*(10^(-3)); //emitter current
5 Beta=150; //Common Emitter amplification
   factor
6 Rl = 2*(10^(3)); //Load Resistance
7
8 re = Vt/Ie;
9 Zi = Beta*re;
10 disp(Zi,"Input Impedance(ohms) is : ");
11
12 Av = -(Rl/re);
13 disp(Av,"Voltage gain is :");
14
15 Ai = Beta;
16 disp(Ai,"Current gain is :");

```

Scilab code Exa 5.3 Common emitter hybrid and common base model

```

1 clear; clc; close;
2
3 Vt=26*(10^(-3)); //thermal voltage
4 Ie=3.2*(10^(-3)); //emitter current
5 Beta = 150; //Common Emitter amplification factor
6 h_oe = 25*(10^(-6));

```

```

7 h_ob =0.5*(10^(-6));
8
9 re = Vt/Ie;
10 h_ie = Beta*re;
11 r_o = 1/h_oe;
12 disp("For the common emitter hybrid equivalent
      circuit :-")
13 disp(re, 're(ohms) =');
14 disp(h_ie,"hie(ohms) = ");
15 disp(r_o,"hoe(ohms) = ");
16
17 r_o = 1/h_ob;
18 alpha = 1; //approximation
19 disp("For the common base re model :-")
20 disp(re, 're(ohms) =');
21 disp(alpha,"alpha = ");
22 disp(r_o,"ro(ohms) = ");

```

Scilab code Exa 5.4 Network characteristics determination

```

1 clear; clc; close;
2
3 Vcc = 15;
4 Vbe = 0.7;
5 Vt = 26*(10^(-3));
6 Rb = 470*(10^(3));
7 Rc = 4.7*(10^(3));
8 ro = 50*(10^(3));
9 Beta = 100;
10
11
12 Ib = (Vcc-Vbe)/Rb;
13 Ie = (Beta+1)*Ib;
14 re = Vt/Ie;
15 disp(re,"Value of diode resistive element is :")

```



```

16
17 Zb = Beta*re;    //resistance seen from base into
    the diode
18 Zi = (Rb*Zb)/(Rb+Zb);
19 disp(Zi,"Input impedance(ohms) :");
20
21 disp("At ro = infinity values are :-");
22 Zo = Rc;
23 disp(Zo,"Output impedance(ohms) :");
24
25 Av = -Rc/re;
26 disp(Av,"Voltage gain :");
27
28 disp("At ro = 50kohm, values are :-");
29 Zo_2 = (ro*Rc)/(ro+Rc);
30 disp(Zo_2,"Input impedance(ohms) :");
31
32 Av_2 = -((ro*Rc)/(ro+Rc))/re;
33 disp(Av_2,"Voltage gain :");

```

Scilab code Exa 5.5 Network characteristics determination

```

1 clear; clc; close;
2
3 Vcc = 22;
4 Vbe = 0.7;
5 Vt = 26*(10^(-3));
6 R1 = 56*(10^(3));
7 R2 = 8.2*(10^(3));
8 Re = 1.5*(10^(3));
9 Rc = 6.8*(10^(3));
10 ro = 50*(10^(3));
11 Beta = 90;
12
13

```

```

14 Vb = (R2/(R1+R2))*Vcc;
15 Ve = Vb - Vbe;
16 Ie = Ve/Re;
17 re = Vt/Ie;
18 disp(re,"Value of diode resistive element is :");
19
20 disp("At ro=infinity ,the values are :-");
21 Rx = (R1*R2)/(R1+R2);
22 Zb = Beta*re;
23 Zi = (Rx*Zb)/(Rx+Zb);
24 disp(Zi,"Input Impedance(ohms) :");
25
26 Zo = Rc;
27 disp(Zo,"Output Impedance(ohms) :");
28
29 Av = -Rc/re;
30 disp(Av,"Voltage gain :");
31
32 disp("At ro=1/hoe,the values are :-")
33 disp(Zi,"Input Impedance(ohms) :");
34 Zo_2 = (Rc*ro)/(Rc+ro);
35 disp(Zo_2,"Output Impedance(ohms) :");
36 Av_2 = -((ro*Rc)/(ro+Rc))/re;
37 disp(Av_2,"Voltage gain :");

```

Scilab code Exa 5.6 Network characteristics without Ce

```

1 clear; clc; close;
2
3 Vcc = 20;
4 Vbe = 0.7;
5 Vt = 26*(10^(-3));
6 Re = 0.56*(10^(3));
7 Rc = 2.2*(10^(3));
8 Rb = 470*(10^(3));

```

```

9 ro = 40*(10^(3));
10 Beta = 120;
11
12 Ib = (Vcc-Vbe)/(Rb+(Beta+1)*Re);
13 Ie = (Beta+1)*Ib;
14 re = Vt/Ie;
15 disp(re,"Value of diode resistive element is :");
16
17 Zb = Beta*(re+Re);
18 Zi = (Rb*Zb)/(Rb+Zb);
19 disp(Zi,"Input Impedance(ohms) :");
20
21 Zo = Rc;
22 disp(Zo,"Output Impedance(ohms) :");
23
24 Av = -Beta*Rc/Zb;
25 disp(Av,"Voltage gain :");

```

Scilab code Exa 5.7 Network characteristics with Ce

```

1 clear; clc; close;
2
3 Vcc = 20;
4 Vbe = 0.7;
5 Vt = 26*(10^(-3));
6 Re = 0.56*(10^(3));
7 Rc = 2.2*(10^(3));
8 Rb = 470*(10^(3));
9 ro = 40*(10^(3));
10 Beta = 120;
11
12 Ib = (Vcc-Vbe)/(Rb+(Beta+1)*Re);
13 Ie = (Beta+1)*Ib;
14 re = Vt/Ie;
15 disp(re,"Value of diode resistive element is (in

```

```

        ohms) :");
16
17 Zb = Beta*re;
18 Zi = (Rb*Zb)/(Rb+Zb);
19 disp(Zi,"Input Impedance(ohms) :");
20
21 Zo = Rc;
22 disp(Zo,"Output Impedance(ohms) :");
23
24 Av = -Rc/re;
25 disp(Av,"Voltage gain :");

```

Scilab code Exa 5.8 Network characteristics determination

```

1 clear; clc; close;
2
3 Vcc = 16;
4 Vbe = 0.7;
5 Vt = 26*(10^(-3));
6 R1 = 90*(10^(3));
7 R2 = 10*(10^(3));
8 Re = 0.68*(10^(3));
9 Rc = 2.2*(10^(3));
10 ro = 50*(10^(3));
11 Beta = 210;
12
13 Vb = (R2/(R1+R2))*Vcc;
14 Ve = Vb - Vbe;
15 Ie = Ve/Re;
16 re = Vt/Ie;
17 disp(re,"Value of diode resistive element is(in ohms
    ) :");
18
19 Rb = (R1*R2)/(R1+R2);
20 Zb = Beta*Re;

```

```

21 Zi = (Rb*Zb)/(Rb+Zb);
22 disp(Zi,"Input Impedance(ohms) :");
23
24 Zo = Rc;
25 disp(Zo,"Output Impedance(ohms) :");
26
27 Av = -Rc/Re;
28 disp(Av,"Voltage gain :");

```

Scilab code Exa 5.9 Network characteristics determination with Ce

```

1 clear; clc; close;
2
3 Vcc = 16;
4 Vbe = 0.7;
5 Vt = 26*(10^(-3));
6 R1 = 90*(10^(3));
7 R2 = 10*(10^(3));
8 Re = 0.68*(10^(3));
9 Rc = 2.2*(10^(3));
10 ro = 50*(10^(3));
11 Beta = 210;
12
13 Vb = (R2/(R1+R2))*Vcc;
14 Ve = Vb - Vbe;
15 Ie = Ve/Re;
16 re = Vt/Ie;
17 disp(re,"Value of diode resistive element is(in ohms
   ) :");
18
19 Rb = (R1*R2)/(R1+R2);
20 Zb = Beta*re;
21 Zi = (Rb*Zb)/(Rb+Zb);
22 disp(Zi,"Input Impedance(ohms) :");
23

```

```

24 Zo = Rc;
25 disp(Zo," Output Impedance(ohms) :");
26
27 Av = -Rc/re;
28 disp(Av," Voltage gain :");

```

Scilab code Exa 5.10 Emitter follower Network characteristics determination

```

1 clear; clc; close;
2
3 Vcc = 12;
4 Vbe = 0.7;
5 Vt = 26*(10^(-3));
6 Re = 3.3*(10^(3));
7 Rb = 220*(10^(3));
8 ro = %inf;
9 Beta = 100;
10
11 disp("For ro=infinity the values are:-");
12 Ib = (Vcc-Vbe)/(Rb+(Beta+1)*Re);
13 Ie = (Beta+1)*Ib;
14 re = Vt/Ie;
15 disp(re," Value of diode resistive element is(in ohms
    ) :");
16
17 Zb = (Beta*re) + ((Beta+1)*Re);
18 Zi = (Rb*Zb)/(Rb+Zb);
19 disp(Zi," Input Impedance(ohms) :");
20
21 Zo = (Re*re)/(Re+re);
22 disp(Zo," Output Impedance(ohms) :");
23
24 Av = Re/(Re+re);
25 disp(Av," Voltage gain :");

```

```

26
27 disp("For ro=25kohm the values are :-")
28 ro_2 = 25*(10^(3));
29
30 Zb_2 = (Beta*re) + ((Beta+1)*Re)/(1+(Re/ro_2));
31 Zi_2 = (Rb*Zb_2)/(Rb+Zb_2);
32 disp(Zi_2,"Input Impedance(ohms) :");
33
34 Zo_2 = (Re*re)/(Re+re);
35 disp(Zo_2,"Output Impedance(ohms) :");
36
37 Av_2 = (((Beta+1)*Re)/Zb_2)/(1+(Re/ro_2));
38 disp(Av_2,"Voltage gain :");

```

Scilab code Exa 5.11 Network characteristics determination

```

1 clear; clc; close;
2
3 Vee = 2;
4 Vbe = 0.7;
5 Vt = 26*(10^(-3));
6 Re = 1*(10^(3));
7 Rc = 5*(10^(3));
8 ro = 1*(10^(6));
9 alpha = 0.98;
10
11 Ie = (Vee-Vbe)/Re;
12 re = Vt/Ie;
13 disp(re,"Value of diode resistive element(re) :");
14
15 Zi = (Re*re)/(Re+re);
16 disp(Zi,"Input Impedance(Zi) :");
17
18 Zo = Rc;
19 disp(Zo,"Output Impedance(Zo) :");

```

```

20
21 Av = Rc/re;
22 disp(Av," Voltage gain (Av) :");
23
24 Ai = -alpha;
25 disp(Ai," Current gain (Ai) :");

```

Scilab code Exa 5.12 Network characteristics determination

```

1 clear; clc; close;
2
3 Vcc = 9;
4 Vbe = 0.7;
5 Vt = 26*(10^(-3));
6 Rf = 180*(10^(3));
7 Rc = 2.7*(10^(3));
8 Beta = 200;
9 ro = %inf;
10
11 disp(" Values at ro=infinity are :-");
12 Ib = (Vcc-Vbe)/(Rf+(Beta*Rc));
13 Ie = (Beta+1)*Ib;
14 re = Vt/Ie;
15 disp(re," Value of diode resistive element(re) :");
16
17 Zi = re/((1/Beta)+(Rc/Rf));
18 disp(Zi," Input Impedance(Zi) :");
19
20 Zo = (Rc*Rf)/(Rc+Rf);
21 disp(Zo," Output Impedance(Zo) :");
22
23 Av = -Rc/re;
24 disp(Av," Voltage gain (Av) :");
25 disp(" Values at ro=25kohm are :- ");
26 ro_2 = 20*(10^(3));

```



```

27
28 Zi_2 = (1+((Rc*ro_2)/(Rc+ro_2))/Rf)/((1/(Beta*re))
          +(1/Rf)+(((Rc*ro_2)/(Rc+ro_2))/(Rf*re)));
29 disp(Zi_2,"Input Impedance(Zi) :");
30
31 Zo_2 = (ro_2*Rc*Rf)/(ro_2*Rc+Rc*Rf+Rf*ro_2);
32 disp(Zo_2,"Output Impedance(Zo) :");
33
34 Av_2 = -[1/Rf + 1/re]*[ro_2*Rc/(ro_2+Rc)]/[1+[(ro_2*
          Rc)/(ro_2+Rc)]/Rf];
35 disp(Av_2,"Voltage gain(Av) :");

```

Scilab code Exa 5.13 Network characteristics determination

```

1 clear; clc; close;
2
3 Vcc = 12;
4 Vbe = 0.7;
5 Vt = 26*(10^(-3));
6 Rc = 3*(10^(3));
7 Rf1 = 120*(10^(3));
8 Rf2 = 68*(10^(3));
9 Rf = Rf1 + Rf2;
10 ro = 30*(10^(3));
11 Beta = 140;
12
13 Ib = (Vcc-Vbe)/(Rf+Beta*Rc);
14 Ie = (1+Beta)*Ib;
15 re = Vt/Ie;
16 disp(re,"Value of diode resistive element(re) :");
17
18 Zb = Beta*re;
19 Zi = (Rf1*Zb)/(Rf1+Zb);
20 disp(Zi,"Input Impedance(Zi) :");
21

```

```

22 Zo = (Rc*Rf2)/(Rc+Rf2);
23 disp(Zo," Output Impedance(Zo) :");
24
25 Av = -[(Rf2*Rc)/(Rf2+Rc)]/re;
26 disp(Av," Voltage gain(Av) :");

```

Scilab code Exa 5.14 Fixed Bias Network characteristics

```

1 clear; clc; close;
2
3 Vcc = 15;
4 Vbe = 0.7;
5 Vt = 26*(10^(-3));
6 Rb = 470*(10^(3));
7 Rc = 4.7*(10^(3));
8 Rl = 4.7*(10^(3));
9 Rs = 0.3*(10^(3));
10 ro = 50*(10^(3));
11 Beta = 100;
12
13
14 Ib = (Vcc-Vbe)/Rb;
15 Ie = (Beta+1)*Ib;
16 re = Vt/Ie;
17 disp(re," Value of diode resistive element(re) :")
18
19 Zb = Beta*re;
20 Zi_prev = (Rb*Zb)/(Rb+Zb);
21 disp(Zi_prev," Input Impedance(Zi) :");
22
23 Zo_prev = Rc;
24 disp(Zo_prev," Output Impedance(Zo) :");
25
26 Av_prev = -Rc/re;
27 disp(Av_prev," Voltage gain(Av) with no-load :");

```

```

28
29
30
31 Av = -[(Rc*Rl)/(Rc+Rl)]/re;
32 disp(Av,"Voltage gain(Av) with 4.7kohm load :");
33
34 Avs = (Zi_prev/(Zi_prev+Rs))*Av;
35 disp(Avs,"Voltage gain(Avs) from source to output
    with 4.7kohm load :");
36 disp(Av_prev,"Voltage gain(Av) with no-load :");

```

Scilab code Exa 5.15 Av and Avs

```

1 clear; clc; close;
2
3 Rl = 4.7*(10^(3));
4 Rs = 0.3*(10^(3));
5 Ro = 4.7*(10^(3));
6 Zi = 846.1;
7 Zo = 4.7*(10^(3));
8 AvNL = -555.55; //gain under no-load condition
9
10 Av = {Rl/(Rl+Ro)}*AvNL;
11 disp(Av,"Voltage gain(Av) with 4.7kohm load :");
12
13 Avs = (Zi/(Zi+Rs))*(Rl/(Rl+Ro))*AvNL;
14 disp(Avs,"Voltage gain(Avs) from source to output
    with 4.7kohm load :");

```

Scilab code Exa 5.16 Network characteristics determination

```

1 clear; clc; close;
2

```

```

3 Zi = 4*(10^(3));
4 Zo = 2*(10^(3));
5 Rs = 0.2*(10^(3));
6 AvNL = -480;
7 disp(AvNL,"Voltage gain(Av) with no-load :")
8
9 Rl = 1.2*(10^(3));
10 Av = {Rl/(Rl+Zo)}*AvNL;
11 disp(Av,"Voltage gain(Av) with 1.2kohm load :");
12
13 Rl = 5.6*(10^(3));
14 Av = {Rl/(Rl+Zo)}*AvNL;
15 disp(Av,"Voltage gain(Av) with 5.6kohm load :");
16
17 Rl = 1.2*(10^(3));
18 Avs = {Zi/(Zi+Rs)}*{Rl/(Rl+Zo)}*AvNL;
19 disp(Avs,"Voltage gain(Avs) from source to output
      with 1.2kohm load :");
20
21 Rl = 5.6*(10^(3));
22 Ai = -Av*(Zi/Rl);
23 disp(Ai,"Current gain with 5.6kohm load :");

```

Scilab code Exa 5.17 Network characteristics determination

```

1 clear; clc; close;
2
3 Rs = 1*(10^(3));
4 Rl = 8.2*(10^(3));
5
6 Zi1 = 10*(10^(3));
7 Zo1 = 12;
8 AvNL1 = 1;
9 Vi1 = rand();
10

```

```

11 Zi2 = 26;
12 Zo2 = 5.1*(10^(3));
13 AvNL2 = 240;
14 Vi2 = rand();
15
16 Vo1 = (Zi2/(Zi2+Zo1))*AvNL1*Vi1;
17 Av1 = Vo1/Vi1;
18 disp(Av1," Voltage gain(Av1) for first stage :");
19
20 Vo2 = (R1/(R1+Zo2))*AvNL2*Vi2;
21 Av2 = Vo2/Vi2;
22 disp(Av2," Voltage gain(Av2) for second stage :");
23
24 Avt = Av1*Av2;
25 disp(Avt," Total Voltage gain(Avt) :");
26
27 Avs = {Zi1/(Zi1+Rs)}*Avt;
28 disp(Avs," Total Voltage gain(Avs) from source:");
29
30 Ait = -Avt*(Zi1/R1);
31 disp(Ait," Total current gain(Ai) :");
32
33 Vs = rand();
34 Vi = {Zi2/(Zi2+Rs)}*Vs;
35 Avs = (Vi/Vs)*Av2;
36 disp(Avs," Total gain if emitter-follower
    configuration removed :");

```

Scilab code Exa 5.18 Network characteristics determination

```

1 clear; clc; close;
2
3 Vi = 25*(10^(-6));
4 Beta = 200;
5 R1 = 15*(10^(3));

```

```

6 R2 = 4.7*(10^(3));
7 Rc = 2.2*(10^(3));
8 Zo = Rc;
9 Re = 1*(10^(3));
10
11 Vb = 4.7;
12 Ve = 4;
13 Vc = 11;
14 Vt = 26*(10^(-3));
15 Ie = 4*(10^(-3));
16
17 re = Vt/Ie;
18 Zb = Beta*re;
19 Zi2 = (R1*R2*Zb)/(R1*R2 + R2*Zb + Zb*R1);
20 Av1 = -(Rc*Zi2)/(Rc+Zi2)/re;
21 AvNL2 = -Rc/re;
22 AvT_NL = Av1*AvNL2;
23 disp(AvT_NL,"No-load voltage gain(Avt(NL)) :");
24
25 Vo = AvT_NL*Vi;
26 disp(Vo,"Voltage gain(Vo) :");
27
28 Rl = 10*(10^(3));
29 Avt = {Rl/(Rl+Zo)}*AvT_NL;
30 disp(Avt,"Voltage gain(Avt) when 10kohm load applied
to stage 2:");
31
32 Zi1 = Zi2;
33 disp(Zi1,"input impedance of first stage(Zi1) :");
34
35 Zo2 = Rc;
36 disp(Zo2,"Output impedance of second stage(Vo2) :");

```

Scilab code Exa 5.19 No load voltage gain

```

1 clear; clc; close;
2
3 Vcc = 18;
4 Vt = 26*(10^(-3));
5 Beta = 200;
6
7 Vb1 = 4.9;
8 Vb2 = 10.8;
9 Ic1 = 3.8*(10^(-3));
10 Ic2 = 3.8*(10^(-3));
11 Ie = Ic1;
12 Re1 = 1.1*(10^(3));
13 Rc2 = 1.8*(10^(3));
14
15
16 re = Vt/Ie;
17 Rc1 = re;
18 Av1 = -Rc1/re;
19
20 Av2 = Rc2/re;
21 Avt = Av1*Av2;
22 disp(Avt,"no-load voltage gain(Avt) :");

```

Scilab code Exa 5.20 Dc bias voltage and current

```

1 clear; clc; close;
2
3 Vcc = 18;
4 Vbe = 1.6;
5 Rb = 3.3*(10^(6));
6 Re = 390;
7 Beta = 8000;
8
9 Ib = (Vcc-Vbe)/(Rb+(Beta*Re));
10 disp(Ib,"Ib :");

```

```
11 Ie = (Beta+1)*Ib;
12 disp(Ie," Ie :");
13 Ve = Ie*Re;
14 disp(Ve," Ve :");
15 Vb = Ve+Vbe;
16 disp(Vb," Vb :");
17 disp(Vcc," Vc :");
```

Scilab code Exa 5.21 Input impedance

```
1 clear; clc; close;
2
3 ri = 5*(10^(3));
4 Rb = 3.3*(10^(6));
5 Beta = 8000;
6 Re = 390;
7
8 Zb = ri + (Beta*Re);
9 Zi = (Rb*Zb)/(Rb+Zb);
10 disp(Zi,"input impedance(Zi) :");
```

Scilab code Exa 5.22 Ac current gain

```
1 clear; clc; close;
2
3 Rb = 3.3*(10^(6));
4 Beta = 8000;
5 Re = 390;
6
7 Ai = (Beta*Rb)/(Rb+Beta*Re);
8 disp(Ai,"ac current gain(Ai) :");
```

Scilab code Exa 5.23 Output impedance

```
1 clear; clc; close;
2
3 Beta = 8000;
4 Re = 390;
5 ri = 5*(10^(3));
6
7 x = ri/Beta;
8 Zo = (Re*ri*x)/(Re*ri+ri*x+x*Re);
9 disp(Zo,"output impedance(Zo) :");
```

Scilab code Exa 5.24 Ac voltage gain

```
1 clear; clc; close;
2
3 Beta = 8000;
4 Re = 390;
5 ri = 5*(10^(3));
6
7 Av = (Re+(Beta*Re))/(ri+(Re+Beta*Re));
8 disp(Av,"ac voltage gain(Av) :");
```

Scilab code Exa 5.25 Dc bias voltage and current

```
1 clear; clc; close;
2
3 Vcc = 18;
4 Veb1 = 0.7;
```

```

5 Rb = 2*(10^(6));
6 Rc = 75;
7 Beta1 = 140;
8 Beta2 = 180;
9
10 Ib1 = (Vcc-Veb1)/(Rb+(Beta1*Beta2*Rc));
11 Ic1 = Beta1*Ib1;
12 Ib2 = Ic1;
13 disp(Ib2," Ib :");
14 Ic2 = Beta2*Ib2;
15 disp(Ic2," Ic :");
16 Ie1 = Ic1-Ib1;
17 Ic = Ie1+Ic2;
18 disp(Ic," Ic (Total) :");
19 Vo_dc = Vcc-Ic*Rc;
20 disp(Vo_dc,"Dc voltage (Ouput) :");
21 Vi_dc = Vo_dc-Veb1;
22 disp(Vi_dc,"Dc voltage (Input) :");

```

Scilab code Exa 5.26 Ac circuit values of Zi Zo Ai Av

```

1 clear; clc; close;
2
3 Vcc = 18;
4 Veb1 = 0.7;
5 Rb = 2*(10^(6));
6 Rc = 75;
7 Beta1 = 140;
8 Beta2 = 180;
9 ri1 = 3*(10^(3));
10
11 Zb = ri1+(Beta1*Beta2*Rc);
12 Zi = (Rb*Zb)/(Rb+Zb);
13 disp(Zi,"Input impedance (Zi) :");
14

```

```

15 Ai = (Beta1*Beta2)*(Rb/(Rb+Zi));
16 disp(Ai," Current gain (Ai) :");
17
18 Zo = ri1/(Beta1*Beta2);
19 disp(Zo," Output impedance (Zo) :");
20 Av = (Beta1*Beta2*Rc)/((Beta1*Beta2*Rc)+ri1);
21 disp(Av," volatge gain (Av) :");

```

Scilab code Exa 5.27 Mirrored Current

```

1 clear; clc; close;
2
3 Vcc = 12;
4 Vbe = 0.7;
5 Rx = 1.1*(10^(3));
6
7 Ix = (Vcc-Vbe)/Rx;
8 disp(Ix," Mirrored current :");

```

Scilab code Exa 5.28 Current through transistors

```

1 clear; clc; close;
2
3 Vcc = 6;
4 Vbe = 0.7;
5 Rx = 1.3*(10^(3));
6
7 Ix = (Vcc-Vbe)/Rx;
8 disp(Ix," Current through each transistor :");

```

Scilab code Exa 5.29 Constant current

```
1 clear; clc; close;
2
3 Vee = 20;
4 Vbe = 0.7;
5 R1 = 5.1*(10^(3));
6 R2 = R1;
7 Re = 2.2*(10^(3));
8
9 Vb = (R1/(R1+R2))*(-Vee);
10 Ve = Vb - Vbe;
11 Ie = (Ve-(-Vee))/Re;
12 disp(Ie,"Constant current :");
```

Scilab code Exa 5.30 Constant current

```
1 clear; clc; close;
2
3 Vee = 18;
4 Vz = 6.2;
5 Vbe = 0.7;
6 Re = 1.8*(10^(3));
7
8 I = (Vz-Vbe)/Re;
9 disp(I,"Constant current :");
```

Scilab code Exa 5.31 Network characteristics determination

```
1 clear; clc; close;
2
3 Vcc = 10;
4 Vbe = 0.7;
```

```

5 hfe = 120;
6 hie = 1.175*(10^(3));
7 hoe = 20*(10^(-6));
8 Rb = 470*(10^(3));
9 Rc = 2.7*(10^(3));
10
11 Zi = (Rb*hie)/(Rb+hie);
12 disp(Zi,"Input impedance(Zi) :");
13 ro = 1/hoe;
14 Zo = (ro*Rc)/(ro+Rc);
15 disp(Zo,"Output impedance(Zo) :");
16 Av = -hfe*Zo/hie;
17 disp(Av,"Voltage gain(Av) :");
18 Ai = hfe;
19 disp(Ai,"Current gain(Ai) :");

```

Scilab code Exa 5.32 Network characteristics determination

```

1 clear; clc; close;
2
3 hfb = -0.99;
4 hib = 14.3;
5 hob = 0.5*(10^(-6));
6 Re = 2.2*(10^(3));
7 Rc = 3.3*(10^(3));
8
9 Zi = (Re*hib)/(Re+hib);
10 disp(Zi,"Input impedance(Zi) :");
11 ro=1/hob;
12 Zo = (ro*Rc)/(ro+Rc);
13 disp(Zo,"Output impedance(Zo) :");
14 Av = -hfb*Rc/hib;
15 disp(Av,"Voltage gain(Av) :");
16 Ai = hfb;
17 disp(Ai,"Current gain(Ai) :");

```

Scilab code Exa 5.33 Determining parameters using hybrid equivalent model

```
1 clear; clc; close;
2
3 Vcc = 8;
4 hfe = 110;
5 hie = 1.6*(10^(3));
6 hoe = 20*(10^(-6));
7 hre = 2*(10^(-4));
8 Rl = 4.7*(10^(3));
9 Rc = 4.7*(10^(3));
10 Rb = 470*(10^(3));
11 Rs = 1*(10^(3));
12
13 Zi = hie - (hfe*hre*Rl)/(1+hoe*Rl);
14 disp(Zi,"Input impedance using hybrid equivalent :")
    ;
15 disp(hie,"Input impedance using approximate model :")
    )
16 Zi_b = (Rb*hie)/(Rb+hie);
17 disp(Zi_b,"Input impedance including Rb :");
18
19 Av = -hfe*Rl/(hie+(hie*hoe-hfe*hre)*Rl);
20 disp(Av,"Voltage gain using hybrid equivalent :");
21 Av_approx = -hfe*Rl/hie;
22 disp(Av_approx,"Voltage gain using approximate model
    :");
23
24 Ai = hfe/(1+hoe*Rl);
25 disp(Ai,"Current gain using hybrid equivalent :");
26 Ai_approx = hfe;
27 disp(Ai_approx,"Current gain using approximate model
    :");
28
```

```

29 Zo = 1/[hoe-(hfe*hre)/(hie+Rs)];
30 disp(Zo,"Output impedance using hybrid equivalent :")
    );
31 Zo_approx = 1/hoe;
32 disp(Zo_approx,"Output impedance using approximate
    model :");
33 Zo_rc = (Rc*Zo)/(Rc+Zo);
34 disp(Zo_rc,"Output impedance including Rc & using
    hybrid equivalent :");
35 Zo_rc_approx = Rc;
36 disp(Zo_rc_approx,"Output impedance including Rc &
    using approximate model :");

```

Scilab code Exa 5.34 Determining parameters using hybrid equivalent model

```

1 clear; clc; close;
2
3 hfe = 110;
4 hie = 1.6*(10^(3));
5 hoe = 20*(10^(-6));
6 hre = 2*(10^(-4));
7 Rl = 2.2*(10^(3));
8 Rc = 2.2*(10^(3));
9 R1 = 3*(10^(3));
10 Rs = 1*(10^(3));
11 disp("Common base hybrid parameters are as follows :
    ")
12 hib = hie/(1+hfe);
13 disp(hib,"hib :");
14 hrb = (hie*hoe)/(1+hfe)-hre;
15 disp(hrb,"hrb :");
16 hfb = -hfe/(1+hfe);
17 disp(hfb,"hfb :");
18 hob = hoe/(1+hfe);
19 disp(hob,"hob :");

```

```

20
21 Zi = hib - (hfb*hrb*Rl)/(1+hob*Rl);
22 disp(Zi,"Input impedance using hybrid equivalent :")
    ;
23 disp(hib,"Input impedance using approximate model :")
    );
24 Zi_b = (Rl*hib)/(Rl+hib);
25 disp(Zi_b,"Input impedance including Rb :");
26
27 Ai = hfb/(1+hob*Rl);
28 disp(Ai,"Current gain using hybrid equivalent :");
29 Ai_approx = hfb;
30 disp(Ai_approx,"Current gain using approximate model
    :");
31
32 Av = -hfb*Rl/(hib+(hib*hob-hfb*hrb)*Rl);
33 disp(Av,"Voltage gain using hybrid equivalent :");
34 Av_approx = -hfb*Rl/hib;
35 disp(Av_approx,"Voltage gain using approximate model
    :");
36
37 Zo = 1/[hob-(hfb*hrb)/(hib+Rs)];
38 disp(Zo,"Output impedance using hybrid equivalent :")
    );
39 Zo_approx = 1/hob;
40 disp(Zo_approx,"Output impedance using approximate
    model :");
41 Zo_rc = (Rc*Zo)/(Rc+Zo);
42 disp(Zo_rc,"Output impedance including Rc & using
    hybrid equivalent :");
43 Zo_rc_approx = Rc;
44 disp(Zo_rc_approx,"Output impedance including Rc &
    using approximate model :");

```

Chapter 6

Field Effect Transistor

Scilab code Exa 6.1 Sketching the transfer curve

```
1 clear; clc; close;
2
3 Idss = 12;
4 Vp = -4;
5 //point 1
6 Vgs1 = Vp/2;
7 Id1 = Idss/4;
8 //point 2
9 Id2 = Idss/2;
10 Vgs2 = 0.3*Vp;
11
12
13 x = [-4 -2 -1.2 0];
14 y = [0 3 6 12];
15 //plot2d(x,y);
16 yi=smooth([x;y],0.1);
17 a = gca();
18 a.thickness = 2;
19 a.y_location = 'right';
```

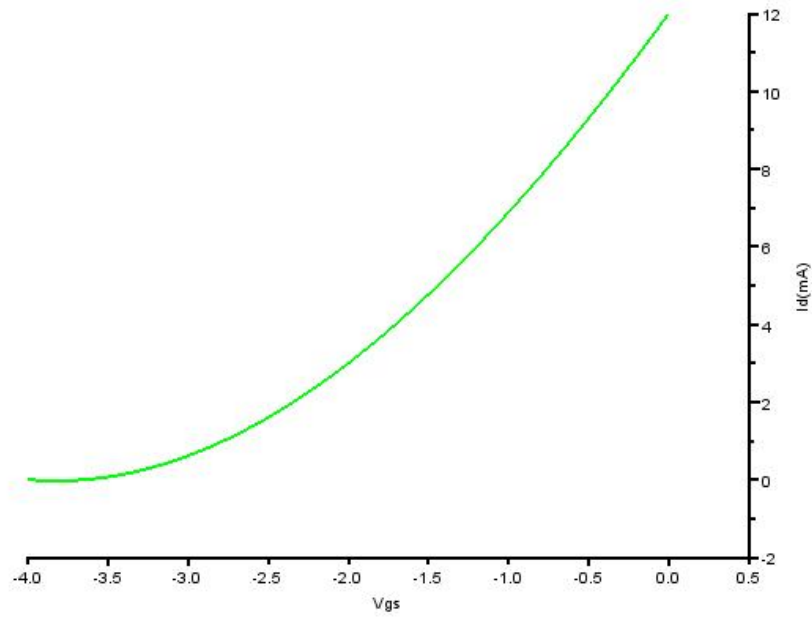

Figure 6.1: Sketching the transfer curve

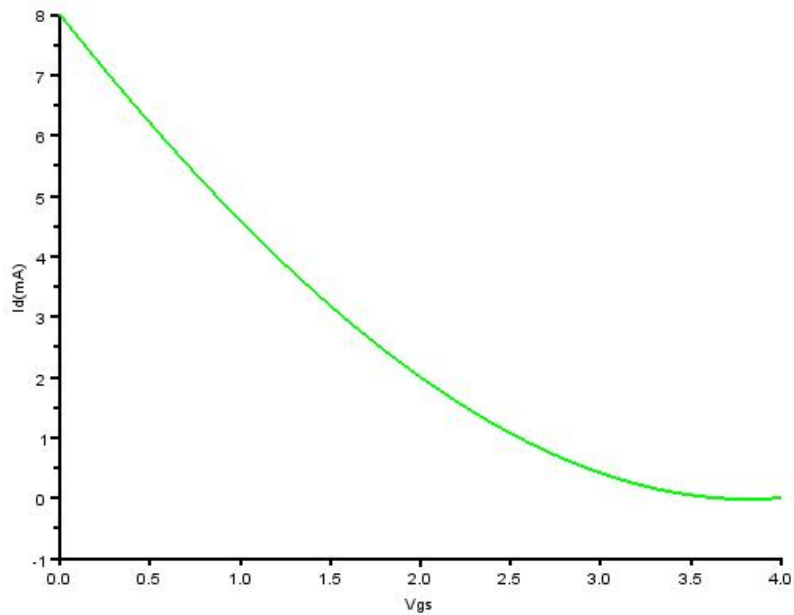

Figure 6.2: Sketching the transfer curve

```

20 a.x_label.text = 'Vgs';
21 a.y_label.text = 'Id (mA)';
22 plot2d(yi(1,:),yi(2,:),[3]);

```

Scilab code Exa 6.2 Sketching the transfer curve

```

1 clear; clc; close;
2
3 Idss = 8;
4 Vp = 4;
5 //point 1

```

```

6 Vgs1 = Vp/2;
7 Id1 = Idss/4;
8 //point 2
9 Id2 = Idss/2;
10 Vgs2 = 0.3*Vp;
11
12
13 x = [0 1.2 2 4];
14 y = [8 4 2 0];
15 yi=smooth([x;y],0.1);
16 a = gca();
17 a.thickness = 2;
18 a.y_location = 'left';
19 a.x_label.text = 'Vgs';
20 a.y_label.text = 'Id(mA)';
21 plot2d(yi(1,:),yi(2,:),[3]);

```

Scilab code Exa 6.3 Sketching the transfer curve

```

1 clear; clc; close;
2
3 Idss = 10;
4 Vp = -4;
5 //point 1
6 Vgs1 = Vp/2;
7 Id1 = Idss/4;
8 //point 2
9 Id2 = Idss/2;
10 Vgs2 = 0.3*Vp;
11 Vgs3 = 1;
12 Id = Idss*(1-Vgs3/Vp)^2;
13 x = [-4 -2 -1.2 1];
14 y = [0 2.5 5 15.63];
15
16 yi=smooth([x;y],0.1);

```

```

17 a = gca();
18 a.thickness = 2;
19 a.y_location = 'middle';
20 a.x_label.text = 'Vgs';
21 a.y_label.text = 'Id (mA)';
22 plot2d(yi(1,:),yi(2,:),[3]);

```

Scilab code Exa 6.4 Sketching the transfer curve and finding value of k

```

1 clear; clc; close;
2
3 Id_on = 3*10^(-3);
4 Vgs_on = 10;
5 Vgs_th = 3;
6 Vt = 3;
7
8 k = Id_on/(Vgs_on-Vgs_th)^2;
9 disp(k,'resulting value of k(A/V^2) is : ');
10
11 Vgs1 = 5;
12 Id1 = k*(Vgs1-Vt)^2;
13 Vgs2 = 8;
14 Id2 = k*(Vgs2-Vt)^2;
15 Vgs3 = 10;
16 Id3 = k*(Vgs3-Vt)^2;
17 Vgs4 = 12;
18 Id4 = k*(Vgs4-Vt)^2;
19 Vgs5 = 14;
20 Id5 = k*(Vgs5-Vt)^2;
21
22 x = [Vt Vgs1 Vgs2 Vgs3 Vgs4 Vgs5];
23 y = [0 Id1 Id2 Id3 Id4 Id5];
24 yi=smooth([x;y],0.1);
25 a = gca();
26 a.thickness = 2;

```

```
27 a.y_location = 'left';
28 a.x_label.text = 'Vgs';
29 a.y_label.text = 'Id(A)';
30 plot2d(yi(1,:),yi(2,:),[3]);
```

Chapter 7

FET Biasing

Scilab code Exa 7.1 Network characteristics determination

```
1 clear; clc; close;
2
3 Vgg = 2;
4 Idss = 10*10^(-3);
5 Vp = -4;
6 Vdd = 16;
7 Rd = 2*10^(3);
8
9 Vgs = -Vgg;
10 Id = Idss*(1-(Vgs/Vp))^2;
11 Vds = Vdd - Id*Rd;
12 Vd = Vds;
13 Vg = Vgs;
14 Vs = 0;
15
16 disp(Vgs, 'Vgsq(Volts) = ');
17 disp(Id, 'Idq(Amperes) = ');
18 disp(Vds, 'Vds(Volts) = ');
19 disp(Vd, 'Vd(Volts) = ');
20 disp(Vg, 'Vg(Volts) = ');
21 disp(Vs, 'Vs(Volts) = ');
```

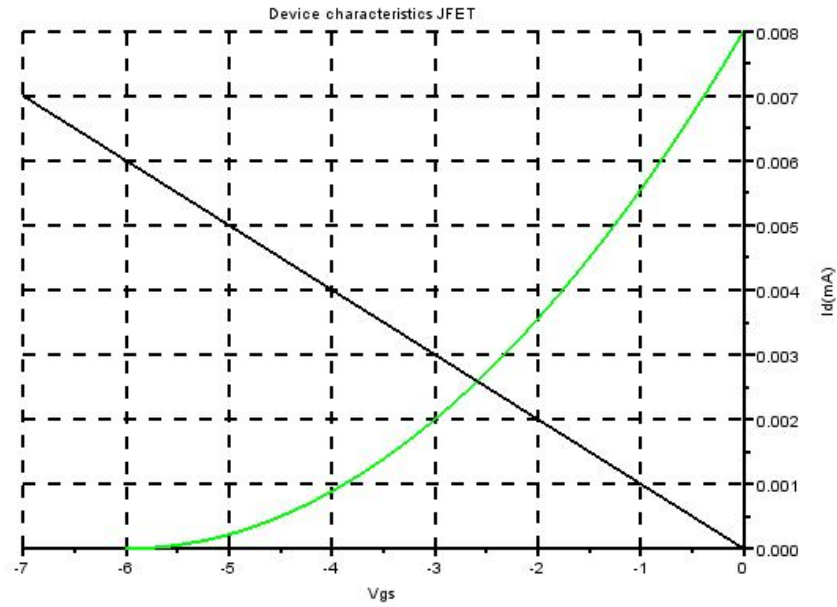

Figure 7.1: Network characteristics determination

Scilab code Exa 7.2 Network characteristics determination

```

1 clear; clc; close;
2
3 Idss = 8*10(-3);
4 Vp = -6;
5 Vdd = 20;
6 Rd = 3.3*10(3);
7 Rs = 1*10(3);
8
9 Vgs1 = Vp;

```



```

10 Id1 = 0;
11 Vgs2 = Vp/2;
12 Id2 = Idss/4;
13 Vgs3 = 0;
14 Id3 = Idss;
15 x = [Vgs1 Vgs2 Vgs3];
16 y = [Id1 Id2 Id3];
17
18 yi=smooth([x;y],0.1);
19 a = gca();
20 a.thickness = 2;
21 a.y_location = 'right';
22 a.x_label.text = 'Vgs';
23 a.y_label.text = 'Id(mA)';
24 a.title.text = 'Device characteristics JFET';
25 a.grid = [1 1];
26 plot2d(yi(1,:),yi(2,:),[3]);
27
28
29 Vgs1 = 0;
30 Id1 = 0;
31 Id2 = 4*10(-3);
32 Vgs2 = -Id2*Rs;
33 Id3 = 8*10(-3);
34 Vgs3 = -Id3*Rs;
35 x = [Vgs1 Vgs2 Vgs3];
36 y = [Id1 Id2 Id3];
37 plot2d(x,y);
38
39 Vgsq = -2.6;
40 disp(Vgsq,'Q-point value of Vgs(found after
    interpolation) is :');
41
42 Idq = 2.6*10(-3);
43 Vds = Vdd - Idq*(Rs+Rd);
44 Vs = Idq*Rs;
45 Vg = 0;
46 Vd = Vds + Vs;

```

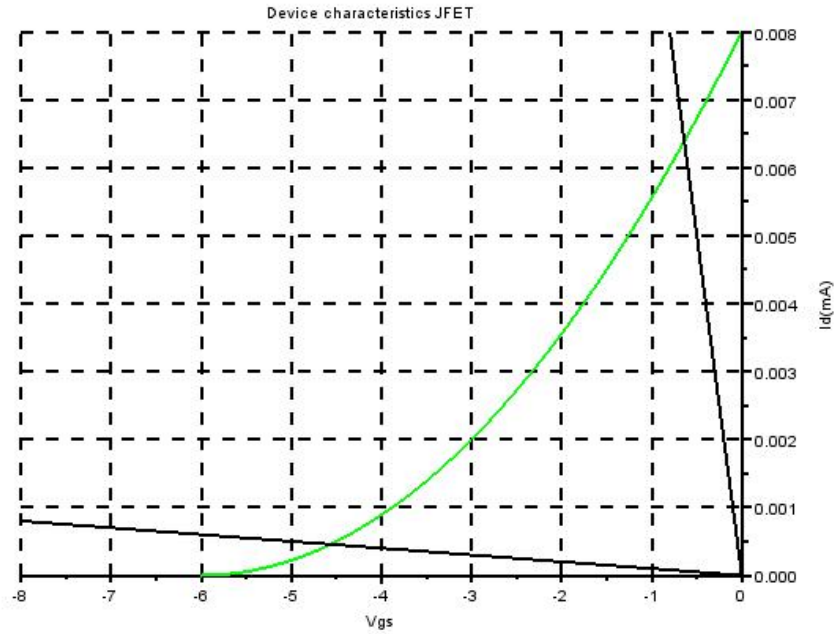

Figure 7.2: Q point for network

```

47
48 disp(Idq, 'Idq (Amperes) = ');
49 disp(Vds, 'Vds (Volts) = ');
50 disp(Vd, 'Vd (Volts) = ');
51 disp(Vg, 'Vg (Volts) = ');
52 disp(Vs, 'Vs (Volts) = ');

```

Scilab code Exa 7.3 Q point for network

```

1 clear; clc; close;
2

```

```

3 Rs = 100;
4 Idss = 8*10(-3);
5 Vp = -6;
6 Vdd = 20;
7
8 Vgs1 = Vp;
9 Id1 = 0;
10 Vgs2 = Vp/2;
11 Id2 = Idss/4;
12 Vgs3 = 0;
13 Id3 = Idss;
14 x = [Vgs1 Vgs2 Vgs3];
15 y = [Id1 Id2 Id3];
16
17 yi=smooth([x;y],0.1);
18 a = gca();
19 a.thickness = 2;
20 a.y_location = 'right';
21 a.x_label.text = 'Vgs';
22 a.y_label.text = 'Id(mA)';
23 a.title.text = 'Device characteristics JFET';
24 a.grid = [1 1];
25
26 plot2d(yi(1,:),yi(2,:),[3]);
27
28
29 Vgs1 = 0;
30 Id1 = 0;
31 Id2 = 4*10(-3);
32 Vgs2 = -Id2*Rs;
33 Id3 = 8*10(-3);
34 Vgs3 = -Id3*Rs;
35 x = [Vgs1 Vgs2 Vgs3];
36 y = [Id1 Id2 Id3];
37 plot2d(x,y);
38
39
40

```

```

41
42 Idq = 6.4*10(-3);
43 Vgsq = -0.64;
44 disp('From the figure ,for part a i.e Rs=100Kohm,we
      get ');
45 disp(Idq, 'Idq(Amperes) = ');
46 disp(Vgsq, 'Vgsq(Volts) = ');
47
48 //part b
49
50 Rs = 10*10(3);
51 Idss = 8*10(-3);
52 Vp = -6;
53 Vdd = 20;
54
55
56
57 Vgs1 = 0;
58 Id1 = 0;
59 Id2 = 4*10(-3);
60 Vgs2 = -Id2*Rs;
61 Id3 = 8*10(-3);
62 Vgs3 = -Id3*Rs;
63 x = [Vgs1 Vgs2 Vgs3];
64 y = [Id1 Id2 Id3];
65 plot2d(x,y);
66 a.data_bounds = [-8 0;0 8*10(-3)];
67 Idq = 0.46*10(-3);
68 Vgsq = -4.6;
69 disp('From the figure ,for part b i.e Rs=10Kohm,we
      get ')
70 disp(Idq, 'Idq(Amperes) = ');
71 disp(Vgsq, 'Vgsq(Volts) = ');

```

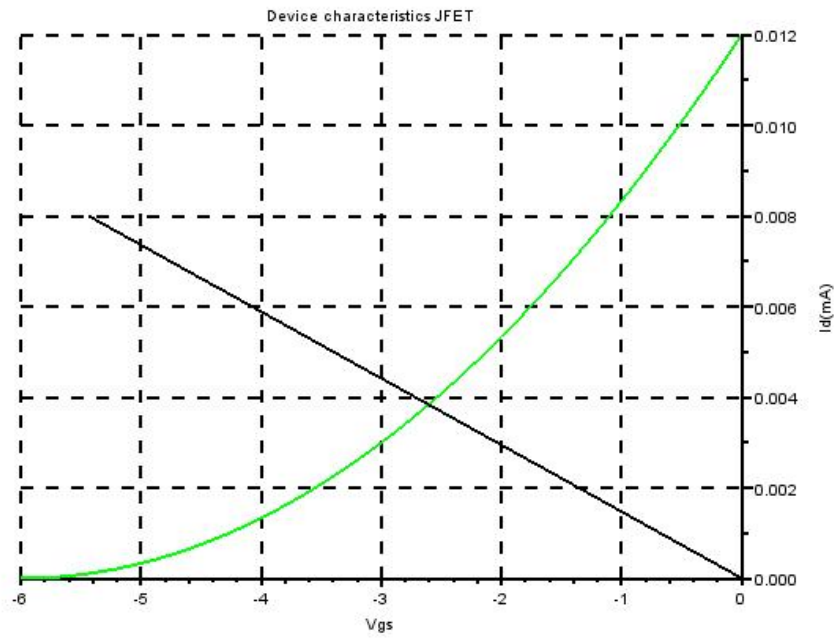

Figure 7.3: Network characteristics determination

Scilab code Exa 7.4 Network characteristics determination

```
1 clear; clc; close;
2
3 Idss = 12*10(-3);
4 Vp = -6;
5 Vdd = 12;
6 Rd = 1.5*10(3);
7 Rs = 680;
8
9 Vgs1 = Vp;
10 Id1 = 0;
11 Vgs2 = Vp/2;
12 Id2 = Idss/4;
13 Vgs3 = 0;
14 Id3 = Idss;
15 x = [Vgs1 Vgs2 Vgs3];
16 y = [Id1 Id2 Id3];
17
18 yi=smooth([x;y],0.1);
19 a = gca();
20 a.thickness = 2;
21 a.y_location = 'right';
22 a.x_label.text = 'Vgs';
23 a.y_label.text = 'Id(mA)';
24 a.title.text = 'Device characteristics JFET';
25 a.grid = [1 1];
26 plot2d(yi(1,:),yi(2,:),[3]);
27
28
29 Vgs1 = 0;
30 Id1 = 0;
31 Id2 = 4*10(-3);
32 Vgs2 = -Id2*Rs;
33 Id3 = 8*10(-3);
34 Vgs3 = -Id3*Rs;
35 x = [Vgs1 Vgs2 Vgs3];
36 y = [Id1 Id2 Id3];
```

```

37 plot2d(x,y);
38
39
40 Vgsq = -2.6;
41 disp(Vgsq, 'Q-point value of Vgs(found after
    interpolation) is :');
42
43 Idq = 3.8*10(-3);
44 Vd = Vdd - Idq*Rd;
45 Vg = 0;
46 Vs = Idq*Rs;
47 Vds = Vd-Vs;
48
49 disp(Idq, 'Idq(Amperes) = ');
50 disp(Vds, 'Vds(Volts) = ');
51 disp(Vd, 'Vd(Volts) = ');
52 disp(Vg, 'Vg(Volts) = ');
53 disp(Vs, 'Vs(Volts) = ');
54 disp(Vds, 'Vds(Volts) = ');

```

Scilab code Exa 7.5 Network characteristics determination

```

1 clear; clc; close;
2
3 Idss = 8*10(-3);
4 Vp = -4;
5 Vdd = 16;
6 Rd = 2.4*10(3);
7 Rs = 1.5*10(3);
8 R1 = 2.1*10(6);
9 R2 = 0.27*10(6);
10 //finding Vg
11 Vg = R2*Vdd/(R1+R2);

```

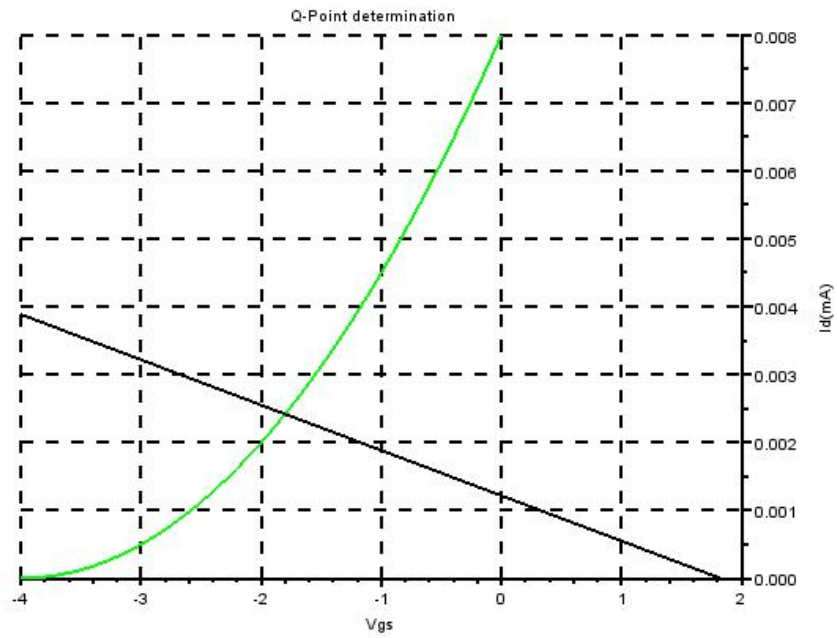

Figure 7.4: Network characteristics determination

```

12
13 //plotting transfer curve
14
15 Vgs1 = Vp;
16 Id1 = 0;
17 Vgs2 = Vp/2;
18 Id2 = Idss/4;
19 Vgs3 = 0;
20 Id3 = Idss;
21 x = [Vgs1 Vgs2 Vgs3];
22 y = [Id1 Id2 Id3];
23
24 yi=smooth([x;y],0.1);
25 a = gca();
26 a.thickness = 2;
27 a.y_location = 'right';
28 a.x_label.text = 'Vgs';
29 a.y_label.text = 'Id(mA)';
30 a.title.text = 'Q-Point determination';
31 a.grid = [1 1];
32 plot2d(yi(1,:),yi(2,:),[3]);
33
34
35 Id1 = 0;
36 Vgs1 = Vg-Id1*Rs;
37 Id2 = 4*10(-3);
38 Vgs2 = Vg-Id2*Rs;
39 Id3 = 8*10(-3);
40 Vgs3 = Vg-Id3*Rs;
41 x = [Vgs1 Vgs2 Vgs3];
42 y = [Id1 Id2 Id3];
43 plot2d(x,y);
44 a.data_bounds = [-4 0;2 8*10(-3)];
45
46
47 Vgsq = -1.8;
48 disp(Vgsq,'Q-point value of Vgs(found after
    interpolation) is :');

```

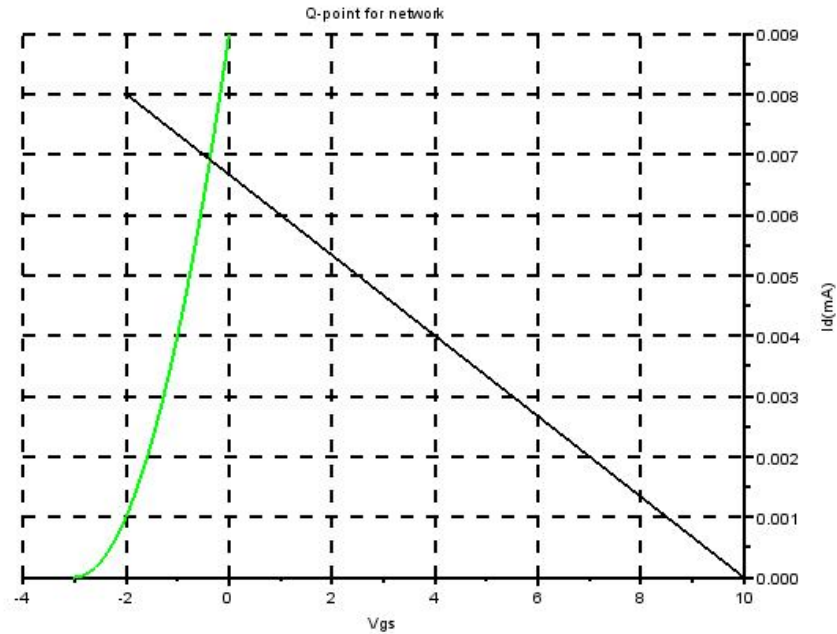

Figure 7.5: Network characteristics determination

```

49
50 Idq = 2.4*10(-3);
51
52 Vd = Vdd-Idq*Rd;
53 Vs = Idq*Rs;
54 Vds = Vdd - Idq*(Rd+Rs);
55
56 disp(Idq, 'Idq (Amperes) = ');
57 disp(Vds, 'Vds (Volts) = ');
58 disp(Vd, 'Vd (Volts) = ');
59 disp(Vs, 'Vs (Volts) = ');
60 disp(Vds, 'Vds (Volts) = ');

```

Scilab code Exa 7.6 Network characteristics determination

```
1 clear; clc; close;
2
3 Idss = 9*10(-3);
4 Vp = -3;
5 Vdd = 20;
6 Vss = 10;
7 Rd = 1.8*10(3);
8 Rs = 1.5*10(3);
9
10
11 Vgs1 = Vp;
12 Id1 = 0;
13 Vgs2 = Vp/2;
14 Id2 = Idss/4;
15 Vgs3 = 0;
16 Id3 = Idss;
17 x = [Vgs1 Vgs2 Vgs3];
18 y = [Id1 Id2 Id3];
19
20 yi=smooth([x;y],0.1);
21 a = gca();
22 a.thickness = 2;
23 a.y_location = 'right';
24 a.x_label.text = 'Vgs';
25 a.y_label.text = 'Id(mA)';
26 a.title.text = 'Q-point for network';
27 a.grid = [1 1];
28 plot2d(yi(1,:),yi(2,:),[3]);
29
30
31
32 Id1 = 0;
```

```

33 Vgs1 = Vss-Id1*Rs;
34 Id2 = 4*10(-3);
35 Vgs2 = Vss-Id2*Rs;
36 Id3 = 8*10(-3);
37 Vgs3 = Vss-Id3*Rs;
38 x = [Vgs1 Vgs2 Vgs3];
39 y = [Id1 Id2 Id3];
40 plot2d(x,y);
41 a.data_bounds = [-3 0;10 9*10(-3)];
42
43
44
45 Vgsq = -0.35;
46 disp(Vgsq,'Q-point value of Vgs(found after
interpolation) is :');
47
48 Idq = 6.9*10(-3);
49
50 Vds = Vdd+Vss-Idq*(Rd+Rs);
51 Vd = Vdd-Idq*Rd;
52 Vs = Vd-Vds;
53
54 disp(Idq,'Idq (Amperes) = ');
55 disp(Vds,'Vds (Volts) = ');
56 disp(Vd,'Vd (Volts) = ');
57 disp(Vs,'Vs (Volts) = ');
58 disp(Vds,'Vds (Volts) = ');

```

Scilab code Exa 7.7 Idq Vgsq and Vds calculation

```

1 clear; clc; close;
2
3 Idss = 6*10(-3);

```

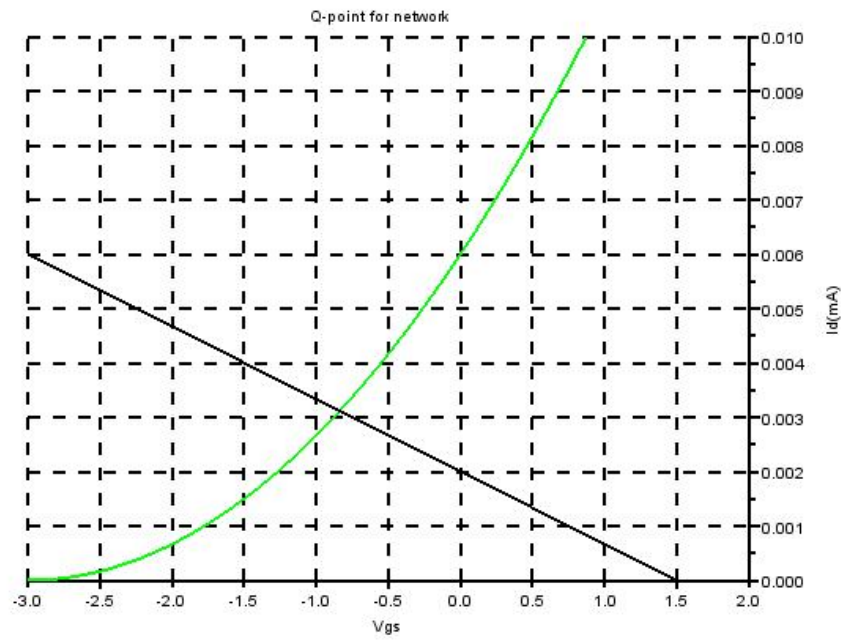

Figure 7.6: I_d V_{gs} and V_{ds} calculation

```

4 Vp = -3;
5 Vdd = 18;
6 Rd = 1.8*10^(3);
7 Rs = 750;
8
9 Vg = 10*10^(6)*18/((10+110)*10^(6));
10
11 Vgs1 = Vp;
12 Id1 = 0;
13 Vgs2 = Vp/2;
14 Id2 = Idss/4;
15 Vgs3 = 0;
16 Id3 = Idss;
17 Vgs4 = 1;
18 Id4 = Idss*(1-(Vgs4/Vp))^2;
19 disp(Id4);
20 x = [Vgs1 Vgs2 Vgs3 Vgs4];
21 y = [Id1 Id2 Id3 Id4];
22
23 yi=smooth([x;y],0.1);
24 a = gca();
25 a.thickness = 2;
26 a.y_location = 'right';
27 a.x_label.text = 'Vgs';
28 a.y_label.text = 'Id(mA)';
29 a.title.text = 'Q-point for network';
30 a.grid = [1 1];
31 plot2d(yi(1,:),yi(2,:),[3]);
32
33
34 Id1 = 0;
35 Vgs1 = Vg-Id1*Rs;
36 Id2 = 3*10^(-3);
37 Vgs2 = Vg-Id2*Rs;
38 Id3 = 6*10^(-3);
39 Vgs3 = Vg-Id3*Rs;
40 x = [Vgs1 Vgs2 Vgs3];
41 y = [Id1 Id2 Id3];

```

```

42 plot2d(x,y);
43 a.data_bounds = [-3 0;2 10*10^(-3)];
44
45
46 Vgsq = -0.8;
47 disp(Vgsq,'Q-point value of Vgs(found after
    interpolation) is :');
48
49 Idq = 3.1*10^(-3);
50
51 Vds = Vdd - Idq*(Rd+Rs);
52
53 disp(Idq,'Idq(Amperes) = ');
54 disp(Vds,'Vds(Volts) = ');

```

Scilab code Exa 7.8 Idq Vgsq and Vds calculation

```

1 clear; clc; close;
2
3 Idss = 6*10^(-3);
4 Vp = -3;
5 Vdd = 18;
6 Rd = 1.8*10^3;
7 Rs = 150;
8
9
10 Vg = 10*10^6*18/((10+110)*10^6);
11
12 Vgs1 = Vp;
13 Id1 = 0;
14 Vgs2 = Vp/2;
15 Id2 = Idss/4;
16 Vgs3 = 0;

```

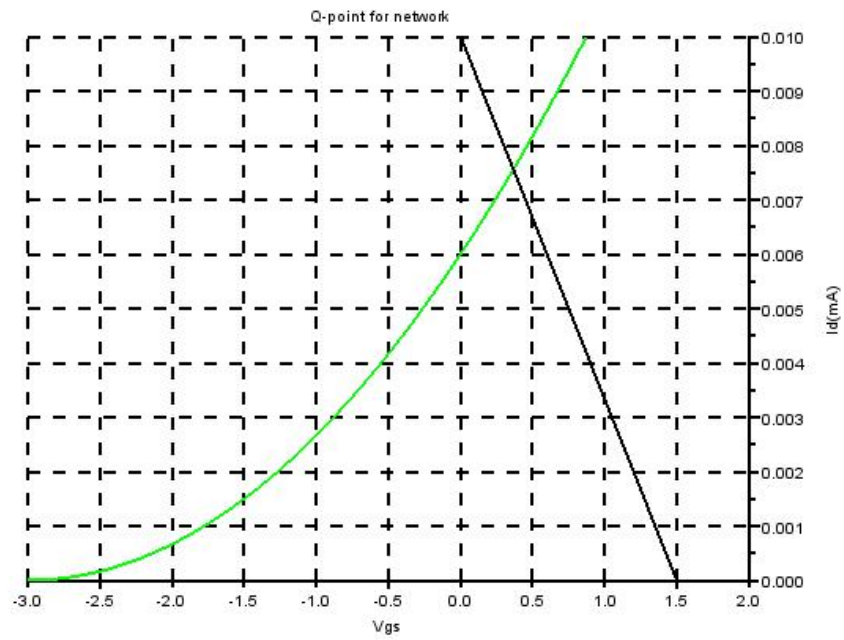

Figure 7.7: I_d V_{gs} and V_{ds} calculation

```

17 Id3 = Idss;
18 Vgs4 = 1;
19 Id4 = Idss*(1-(Vgs4/Vp))^2;
20 disp(Id4);
21 x = [Vgs1 Vgs2 Vgs3 Vgs4];
22 y = [Id1 Id2 Id3 Id4];
23
24 yi=smooth([x;y],0.1);
25 a = gca();
26 a.thickness = 2;
27 a.y_location = 'right';
28 a.x_label.text = 'Vgs';
29 a.y_label.text = 'Id(mA)';
30 a.title.text = 'Q-point for network';
31 a.grid = [1 1];
32 plot2d(yi(1,:),yi(2,:),[3]);
33
34
35 Id1 = 0;
36 Vgs1 = Vg-Id1*Rs;
37 Id2 = 3*10^(-3);
38 Vgs2 = Vg-Id2*Rs;
39 Id3 = 6*10^(-3);
40 Vgs3 = Vg-Id3*Rs;
41 Vgs4 = 0;
42 Id4 = (Vg - Vgs4)/Rs;
43 x = [Vgs1 Vgs2 Vgs3 Vgs4];
44 y = [Id1 Id2 Id3 Id4];
45 plot2d(x,y);
46 a.data_bounds = [-3 0;2 10*10^(-3)];
47
48
49
50
51 Vgsq = 0.35;
52 disp(Vgsq,'Q-point value of Vgs(found after
    interpolation) is :');
53

```

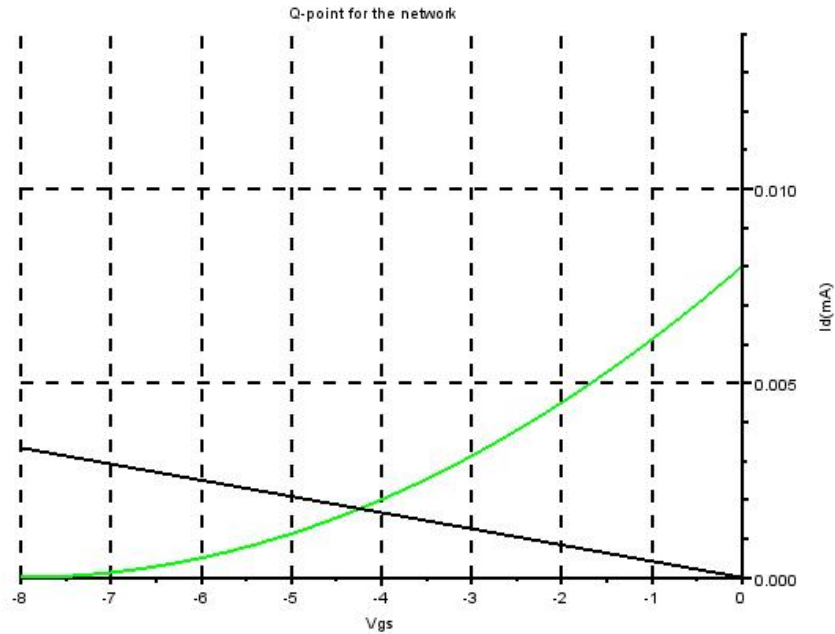

Figure 7.8: Idq Vgsq and Vd calculation

```

54 Idq = 7.6*10^(-3);
55
56 Vds = Vdd - Idq*(Rd+Rs);
57
58 disp(Idq, 'Idq (Amperes) = ');
59 disp(Vds, 'Vds (Volts) = ');

```

Scilab code Exa 7.9 Idq Vgsq and Vd calculation

```

1 clear; clc; close;
2

```

```

3 Idss = 8*10(-3);
4 Vp = -8;
5 Vdd = 20;
6 Rd = 6.2*10(3);
7 Rs = 2.4*10(3);
8
9 Vgs1 = Vp;
10 Id1 = 0;
11 Vgs2 = Vp/2;
12 Id2 = Idss/4;
13 Vgs3 = 0;
14 Id3 = Idss;
15 Vgs4 = 2;
16 Id4 = Idss*(1-(Vgs4/Vp))2;
17 x = [Vgs1 Vgs2 Vgs3 Vgs4];
18 y = [Id1 Id2 Id3 Id4];
19
20 yi=smooth([x;y],0.1);
21 a = gca();
22 a.thickness = 2;
23 a.y_location = 'right';
24 a.x_label.text = 'Vgs';
25 a.y_label.text = 'Id(mA)';
26 a.title.text = 'Q-point for the network';
27 a.grid = [1 1];
28 plot2d(yi(1,:),yi(2,:),[3]);
29
30
31 Vgs1 = 0;
32 Id1 = 0;
33 Id2 = 4*10(-3);
34 Vgs2 = -Id2*Rs;
35 Id3 = 8*10(-3);
36 Vgs3 = -Id3*Rs;
37 x = [Vgs1 Vgs2 Vgs3];
38 y = [Id1 Id2 Id3];
39 plot2d(x,y);
40 a.data_bounds = [-8 0;0 13*10(-3)];

```

```

41
42
43 Vgsq = -4.3;
44 disp(Vgsq, 'Q-point value of Vgs(found after
    interpolation) is :');
45
46 Idq = 1.7*10(-3);
47
48 Vd = Vdd - Idq*(Rd);
49
50 disp(Idq, 'Idq(Amperes) = ');
51 disp(Vd, 'Vd(Volts) = ');

```

Scilab code Exa 7.10 Vds determination

```

1 clear; clc; close;
2
3 Idss = 10*10(-3);
4 Vp = -4;
5 Vdd = 20;
6 Rd = 1.5*10(3);
7
8 Vgsq = 0;
9 disp(Vgsq, 'Q-point value of Vgs(found after
    interpolation) is :');
10
11 Idq = 10*10(-3);
12
13 Vd = Vdd - Idq*(Rd);
14
15 disp(Idq, 'Idq(Amperes) = ');
16 disp(Vd, 'Vds(Volts) = ');

```

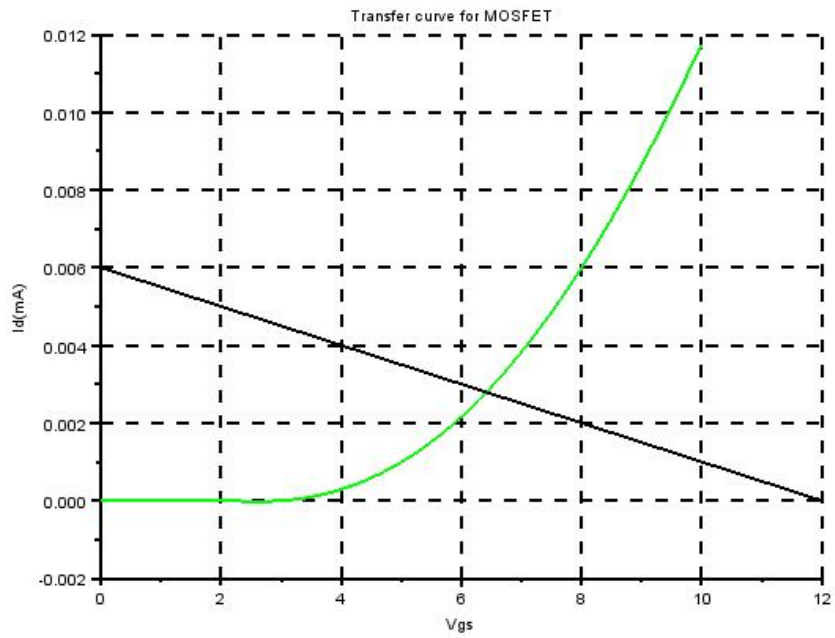

Figure 7.9: Idq Vdsq Calculation

Scilab code Exa 7.11 Idq Vdsq Calculation

```
1 clear; clc; close;
2
3 Id_on = 6*10^(-3);
4 Vgs_on = 8;
5 Vgs_th = 3;
6 Rd = 2*10^(3);
7 Vdd = 12;
8
9 k = Id_on/(Vgs_on-Vgs_th);
10
11 Vgs1 = Vgs_th;
12 Id1 = 0;
13 Vgs2 = 6;
14 Id2 = 0.24*10^(-3)*(6-3)^2;
15 Vgs3 = Vgs_on;
16 Id3 = Id_on;
17 Vgs4 = 10;
18 Id4 = 0.24*10^(-3)*(10-3)^2;
19
20 x = [0 1 2 Vgs1 Vgs2 Vgs3 Vgs4];
21 y = [0 0 0 Id1 Id2 Id3 Id4];
22
23 yi=smooth([x;y],0.1);
24 a = gca();
25 a.thickness = 2;
26 a.y_location = 'left';
27 a.x_label.text = 'Vgs';
28 a.y_label.text = 'Id(mA)';
29 a.title.text = 'Transfer curve for MOSFET';
30 a.grid = [1 1];
31 plot2d(yi(1,:),yi(2,:),[3]);
32
```

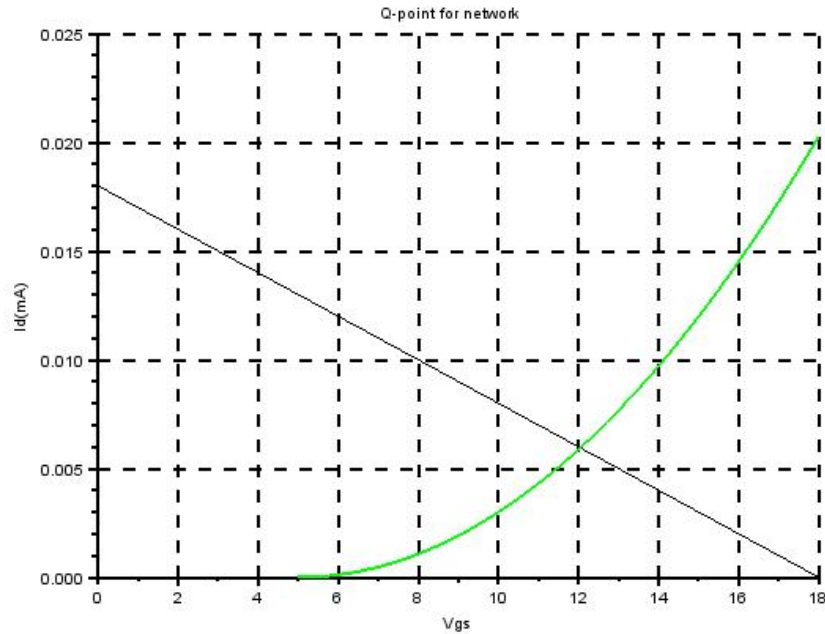

Figure 7.10: Idq Vgsq and Vds calculation

```

33 Vgs = Vdd; //at Id = 0
34 Id = Vdd/Rd; //at Vgs = 0
35 x = 0:1:12;
36 y = (-0.5*10^(-3))*x + 6*10^(-3);
37 plot2d(x,y);
38 Idq = 2.75*10^(-3);
39 Vgsq = 6.4;
40 Vdsq = Vgsq;
41 disp(Idq, 'Idq (Amperes) = ');
42 disp(Vdsq, 'Vdsq (Volts) = ');

```

Scilab code Exa 7.12 Idq Vgsq and Vds calculation

```
1 clear; clc; close;
2
3 Id_on = 3*10^(-3);
4 Vgs_on = 10;
5 Vgs_th = 5;
6 Vdd = 40;
7 R1 = 22*10^(6);
8 R2 = 18*10^(6);
9 Rs = 1*10^(3);
10 Rd = 3*10^(3);
11
12 Vg = (R2*Vdd)/(R1+R2)
13 Vgs = 0:1:18;
14 Id = (Vg-Vgs)/Rs;
15 plot2d(Vgs,Id);
16 a = gca();
17 a.thickness = 2;
18 a.y_location = 'left';
19 a.x_label.text = 'Vgs';
20 a.y_label.text = 'Id(mA)';
21 a.title.text = 'Q-point for network';
22 a.grid = [1 1];
23
24 k = Id_on/(Vgs_on-Vgs_th)^2;
25 Vgs = 5:1:18;
26 Id = k*(Vgs-Vgs_th)^2;
27 yi=smooth([Vgs;Id],0.1);
28 plot2d(yi(1,:) ',yi(2,:) ',[3]);
29
30 Idq = 5.2*10^(-3);
31 Vgsq = 12.5;
32 Vds = Vdd-Idq*(Rs+Rd);
33
34 disp(Idq, 'Idq (Amperes) = ');
35 disp(Vgsq, 'Vgsq (Volts) = ');
36 disp(Vds, 'Vds (Volts) = ');
```

Scilab code Exa 7.13 Vd and Vc level determination

```
1 clear; clc; close;
2
3 Idss = 12*10(-3);
4 Vp = -3;
5 Vbe = 0.7;
6 Beta = 180;
7 Re = 1.6*10(3);
8
9 Vb = (24*10(3)*16)/((82+24)*10(3));
10 Ve = Vb-Vbe;
11 Vre = Ve;
12 Ie = Vre/Re;
13 Ic = Ie;
14 Id = Ic;
15 Vd = 16-Id*(2.7*10(3));
16 Vgsq = -1.8;
17 Vc = Vb - Vgsq;
18
19 disp(Vd, 'Vd(Volts) = ');
20 disp(Vc, 'Vc(Volts) = ');
```

Scilab code Exa 7.14 Vd level determination

```
1 clear; clc; close;
2
3 Idss = 12*10(-3);
4 Vp = -3;
5 Vbe = 0.7;
6 Beta = 80;
```

```

7 Re = 1.6*10^(3);
8 Rs = 2.4*10^(3);
9
10 Vgsq = -2.6;
11 Idq = 1*10^(-3);
12 Ic = Idq;
13 Ie = Ic;
14 Ib = Ic/Beta;
15 Vb = 16-Ib*(470*10^(3));
16 Vd = Vb-Vbe;
17 disp(Vd, 'Vd(Volts) = ');

```

Scilab code Exa 7.15 Vdq and Idq level

```

1 clear; clc; close;
2
3 Vdd = 20;
4 Vdq = 12;
5 Idq = 2.5*10^(-3);
6 Vgsq = -1;
7 Rd = (Vdd-Vdq)/Idq;
8 Rs = -Vgsq/Idq;
9
10 disp(Rd, 'Rd(Ohms) = ');
11 disp(Rs, 'Rs(Ohms) = ');
12 disp(3.3*10^(3), 'Closest commercial value of Rd(Ohms) = ');
13 disp(0.39*10^(3), 'Closest commercial value of Rs(Ohms) = ');

```

Scilab code Exa 7.16 Rs determination

```

1 clear; clc; close;

```

```

2
3 Vd =12;
4 Vdd = 16;
5 Vgsq = -2;
6 Rd = 1.8*10^(3);
7
8 Vg = (47*10^(3)*16)/((47+91)*10^(3));
9 Id = (Vdd-Vd)/Rd;
10
11 Rs = (Vg-Vgsq)/Id;
12
13 disp(Rs, 'Rs(Ohms) = ');

```

Scilab code Exa 7.17 Vdd and Rd determination

```

1 clear; clc; close;
2
3 Id_on = 4*10^(-3);
4 Vgs_on = 6;
5 Vgs_th = 3;
6
7 Vgs = Vgs_on;
8 Vdd = 2*Vgs;
9 Vds = Vgs;
10 Id = Id_on;
11
12 Rd = (Vdd-Vds)/Id;
13
14 disp(Rd, 'Rd(Ohms) = ');

```

Scilab code Exa 7.18 Idq Vgsq and Vds calculation

```

1 clear; clc; close;

```

```

2
3 Idss = 8*10(-3);
4 Vp = 4;
5 Vdd = 20;
6 Rd = 4*10(3);
7 Rs = 1.8*10(3);
8
9 Vg = 20*10(3)*(-20)/((20+68)*10(3));
10
11 Vgs1 = 0;
12 Id1 = Idss;
13 Vgs2 = Vp/2;
14 Id2 = Idss/4;
15 Vgs3 = Vp;
16 Id3 = 0;
17 x = [Vgs1 Vgs2 Vgs3];
18 y = [Id1 Id2 Id3];
19
20 yi=smooth([x;y],0.1);
21 a = gca();
22 a.thickness = 2;
23 a.data_bounds = [-5 0;5 8*10(-3)];
24 a.y_location = 'middle';
25 a.x_label.text = 'Vgs';
26 a.y_label.text = 'Id(mA)';
27 a.title.text = 'Q-point for network';
28 a.grid = [1 1];
29 plot2d(yi(1,:),yi(2,:),[3]);
30
31
32 Id1 = 0;
33 Vgs1 = Vg+Id1*Rs;
34 Vgs2 = 0;
35 Id2 = (Vgs2-Vg)/Rs;
36 Id3 = 4*10(-3);
37 Vgs3 = Vg+Id3*Rs;
38 x = [Vgs1 Vgs2 Vgs3];
39 y = [Id1 Id2 Id3];

```

```

40 plot2d(x,y);
41
42
43 Vgsq = 1.6;
44 Idq = 3.1*10(-3);
45 Vds = -Vdd+Idq*(Rd+Rs);
46
47 disp(Vgsq, 'Q-point value of Vgs(found after
    interpolation) is :');
48 disp(Idq, 'Q-point value of Id(found after
    interpolation) is :');
49 disp(Vds, 'Vds(Volts) = ');

```

Scilab code Exa 7.19 Q point value of Id and Vgs

```

1 clear; clc; close;
2
3 Idss = 6*10(-3);
4 Vp = -3;
5 Vdd = 16;
6 Rd = 3.9*10(3);
7 Rs = 1.6*10(3);
8
9 m = abs(Vp)/(Idss*Rs);
10 Idq = 0.18*Idss;
11 Vgsq = -0.575*abs(Vp);
12
13 disp(Vgsq, 'Vgsq(Volts) = ');
14 disp(Idq, 'Idq(Amperes) = ');

```

Scilab code Exa 7.20 Q point value of Id and Vgs

```

1 clear; clc; close;

```

```
2
3 Idss = 8*10(-3);
4 Vp = -6;
5 Vdd = 18;
6 Rs = 1.2*10(3);
7 R1 = 2*10(6);
8 R2 = 470*10(3);
9
10 m = abs(Vp)/(Idss*Rs);
11 Vg = R2*Vdd/(R1+R2);
12 M = m*(Vg/abs(Vp));
13
14 Idq = 0.52*Idss;
15 Vgsq = -0.27*abs(Vp);
16
17 disp(Vgsq, 'Vgsq (Volts) = ');
18 disp(Idq, 'Idq (Amperes) = ');
```

Chapter 8

FET Amplifiers

Scilab code Exa 8.1 Calculation of gm for different Vgs

```
1 clear; clc; close;
2
3 Idss = 8*10^(-3);
4 Vp = -4;
5
6
7 Vgs1 = Vp;
8 Id1 = 0;
9 Vgs2 = Vp/2;
10 Id2 = Idss/4;
11 Vgs3 = 0;
12 Id3 = Idss;
13 x = [Vgs1 Vgs2 Vgs3];
14 y = [Id1 Id2 Id3];
15
16 yi=smooth([x;y],0.1);
17 a = gca();
18 a.thickness = 2;
19 a.y_location = 'right';
```

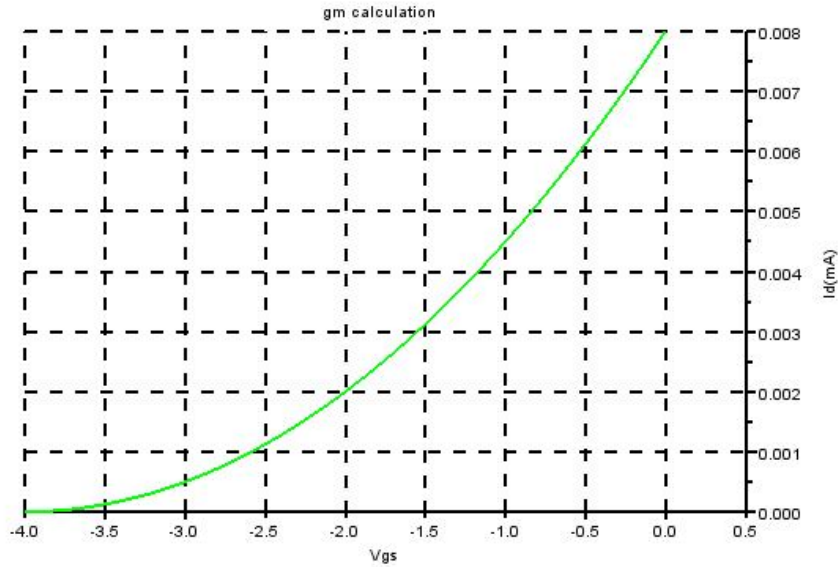

Figure 8.1: Calculation of gm for different Vgs

```

20 a.x_label.text = 'Vgs';
21 a.y_label.text = 'Id(mA)';
22 a.title.text = 'gm calculation';
23 a.grid = [1 1];
24 plot2d(yi(1,:),yi(2,:),[3]);
25
26
27 //part-a
28 Vgs = -0.5;
29 Id_delta = 2.1*10^(-3);
30 Vgs_delta = 0.6;
31
32 gm = Id_delta/Vgs_delta;
33 disp(gm,'gm(in S) for part a = ');
34
35 //part-b
36 Vgs = -1.5;
37 Id_delta = 1.8*10^(-3);

```



```

38 Vgs_delta = 0.7;
39
40 gm = Id_delta/Vgs_delta;
41 disp(gm, 'gm(in S) for part b = ');
42
43 //part-c
44 Vgs = -2.5;
45 Id_delta = 1.5*10^(-3);
46 Vgs_delta = 1;
47
48 gm = Id_delta/Vgs_delta;
49 disp(gm, 'gm(in S) for part c = ');

```

Scilab code Exa 8.2 Calculation of gm for different Vgs and max gm

```

1 clear; clc; close;
2
3 Idss = 8*10^(-3);
4 Vp = -4;
5
6 gmo = 2*Idss/abs(Vp);
7
8 //part-a
9 Vgs = -0.5;
10
11 gm = gmo*(1-(Vgs/Vp));
12 disp(gm, 'gm(in S) for part a = ');
13
14 //part-b
15 Vgs = -1.5;
16 gm = gmo*(1-(Vgs/Vp));
17 disp(gm, 'gm(in S) for part b = ');
18
19 //part-c
20 Vgs = -2.5;

```

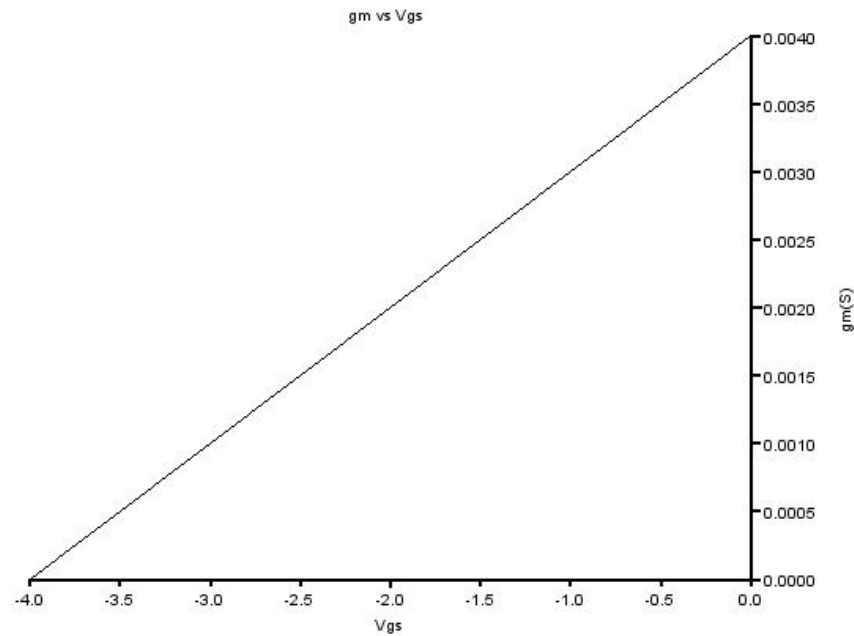

Figure 8.2: gm vs Vgs

```

21 Id_delta = 1.5*10^(-3);
22 Vgs_delta = 1;
23
24 gm = gmo*(1-(Vgs/Vp));
25 disp(gm, 'gm(in S) for part c = ');
26
27 disp(gmo, 'Max gm(in S) is = ')

```

Scilab code Exa 8.3 gm vs Vgs

```

1 clear; clc; close;

```

```

2
3 Vp = -4;
4 gmo = 4*10(-3);
5
6 vgs1 = -4;
7 gm1 = gmo*(1-(vgs1/Vp));
8 vgs2 = -2.5;
9 gm2 = gmo*(1-(vgs2/Vp));
10 vgs3 = -1.5;
11 gm3 = gmo*(1-(vgs3/Vp));
12 vgs4 = -1.5;
13 gm4 = gmo*(1-(vgs4/Vp));
14 vgs5 = 0;
15 gm5 = gmo*(1-(vgs5/Vp));
16
17 x = [vgs1 vgs2 vgs3 vgs4 vgs5];
18 y = [gm1 gm2 gm3 gm4 gm5];
19 plot2d(x,y);
20 a = gca();
21 a.thickness = 2;
22 a.y_location = 'right';
23 a.x_label.text = 'Vgs';
24 a.y_label.text = 'gm(S)';
25 a.title.text = 'gm vs Vgs';

```

Scilab code Exa 8.4 gm vs Id

```

1 clear; clc; close;
2
3 Idss = 8*10(-3);
4 Vp = -4;
5
6 gmo = 2*Idss/abs(Vp);

```

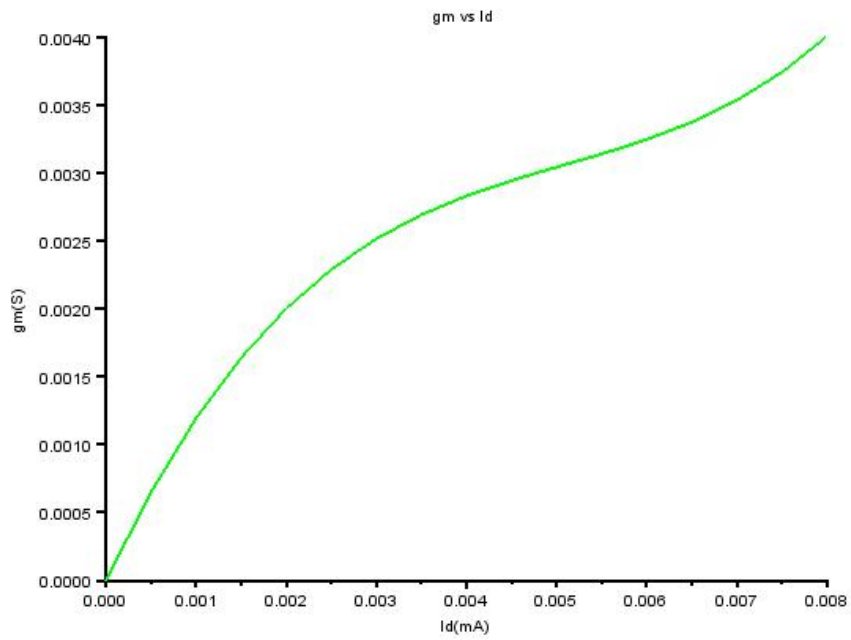

Figure 8.3: g_m vs I_d

```

7
8 Id1 = 0;
9 gm1 = gmo*(sqrt(Id1/Idss));
10 Id2 = Idss/4;
11 gm2 = gmo*(sqrt(Id2/Idss));
12 Id3 = Idss/2;
13 gm3 = gmo*(sqrt(Id3/Idss));
14 Id4 = Idss;
15 gm4 = gmo*(sqrt(Id4/Idss));
16
17 x = [Id1 Id2 Id3 Id4];
18 y = [gm1 gm2 gm3 gm4];
19 yi=smooth([x;y],0.0005);
20 a = gca();
21 a.thickness = 2;
22 a.y_location = 'left';
23 a.x_label.text = 'Id(mA)';
24 a.y_label.text = 'gm(S)';
25 a.title.text = 'gm vs Id';
26 plot2d(yi(1,:),yi(2,:),[3]);

```

Scilab code Exa 8.5 Output impedance

```

1 clear; clc; close;
2
3 Vds = 8;
4
5 Vgs = 0;
6 Vds_delta = 5;
7 Id_delta = 0.2*10^(-3);
8 rd = Vds_delta/Id_delta;
9 disp(rd,'For Vgs = 0V,rd(ohms) = ');
10
11 Vgs = -2;
12 Vds_delta = 8;

```

```
13 Id_delta = 0.1*10(-3);
14 rd = Vds_delta/Id_delta;
15 disp(rd, 'For Vgs = -2V, rd(ohms) = ');
```

Scilab code Exa 8.6 FET equivalent model

```
1 clear; clc; close;
2
3 yfs = 3.8*10(-3);
4 yos = 20*10(-6);
5
6 gm = yfs;
7 rd = 1/yos;
8
9 disp(gm, 'gm(in S) = ');
10 disp(rd, 'rd(ohms) = ');
```

Scilab code Exa 8.7 JFET fix bias configuration calculation

```
1 clear; clc; close;
2
3 yos = 20*10(-6);
4 Idss = 10*10(-3);
5 Vp = -8;
6 Vgsq = -2;
7 Idq = 5.625*10(-3);
8 Rg = 1*10(6);
9 Rd = 2*10(3);
10
11 gmo = 2*Idss/abs(Vp);
12 gm = gmo*(1-(Vgsq/Vp));
13 rd = 1/yos;
14 Zi = Rg;
```

```

15 Zo = Rd*rd/(Rd+rd);
16 Av = -gm*(Rd*rd/(Rd+rd));
17 Av2 = -gm*Rd;
18
19 disp(gm, 'gm(S) = ');
20 disp(rd, 'rd(ohms) = ');
21 disp(Zi, 'Zi(ohms) = ');
22 disp(Zo, 'Zo(ohms) = ');
23 disp(Av, 'Voltage gain Av = ');
24 disp(Av2, 'Volatge gain Av(ignoring rd) = ');

```

Scilab code Exa 8.8 JFET self bias configuration calculation

```

1 clear; clc; close;
2
3 yos = 25*10^(-6);
4 Idss = 8*10^(-3);
5 Vp = -6;
6 Vgsq = -2.6;
7 Idq = 2.6*10^(-3);
8 Rg = 1*10^(6);
9 Rd = 3.3*10^(3);
10 Rs = 1*10^(3);
11
12 gmo = 2*Idss/abs(Vp);
13 gm = gmo*(1-(Vgsq/Vp));
14 rd = 1/yos;
15 Zi = Rg;
16 Zo = Rd;
17 Av = -gm*Rd/(1+gm*Rs+((Rd+Rs)/rd));
18 Av2 = -gm*Rd/(1+gm*Rs);
19
20 disp(gm, 'gm(S) = ');
21 disp(rd, 'rd(ohms) = ');
22 disp(Zi, 'Zi(ohms) = ');

```

```

23 disp(Zo, 'Zo(ohms) = ');
24 disp(Av, 'Voltage gain Av = ');
25 disp(Av2, 'Volatge gain Av(ignoring rd) = ');

```

Scilab code Exa 8.9 JFET source follower configuration calculation

```

1 clear; clc; close;
2
3 yos = 30*10^(-6);
4 Idss = 16*10^(-3);
5 Vp = -4;
6 Vgsq = -2.86;
7 Idq = 4.56*10^(-3);
8 Rg = 1*10^6;
9 Rs = 2.2*10^3;
10
11
12 gmo = 2*Idss/abs(Vp);
13 gm = gmo*(1-(Vgsq/Vp));
14 rd = 1/yos;
15 Zi = Rg;
16 Zo = rd*Rs*gm^(-1)/((rd*Rs)+(Rs*gm^(-1))+(rd*gm^(-1)
    ));
17 Zo2 = Rs*gm^(-1)/(Rs+gm^(-1));
18 Av = gm*(rd*Rs/(rd+Rs))/(1+(gm*(rd*Rs/(rd+Rs))));
19 Av2 = gm*Rs/(1+gm*Rs);
20
21 disp(gm, 'gm(S) = ');
22 disp(rd, 'rd(ohms) = ');
23 disp(Zi, 'Zi(ohms) = ');
24 disp(Zo, 'Zo(ohms) = ');
25 disp(Zo2, 'Zo without rd = ');
26 disp(Av, 'Voltage gain Av = ');
27 disp(Av2, 'Volatge gain Av(ignoring rd) = ');

```

Scilab code Exa 8.10 JFET common gate configuration calculation

```
1 clear; clc; close;
2
3 yos = 50*10^(-6);
4 Idss = 10*10^(-3);
5 Vp = -4;
6 Vgsq = -2.2;
7 Idq = 2.03*10^(-3);
8 Rd = 3.6*10^3;
9 Rs = 1.1*10^3;
10 Vi = 40*10^(-3);
11
12 gmo = 2*Idss/abs(Vp);
13 gm = gmo*(1-(Vgsq/Vp));
14 rd = 1/yos;
15 Zi = Rs*((rd+Rd)/(1+gm*rd))/(Rs+((rd+Rd)/(1+gm*rd)))
    ;
16 Zi2 = Rs*gm^(-1)/(Rs+gm^(-1));
17 Zo = Rd*rd/(Rd+rd);
18 Zo2 = Rd;
19 Av = (gm*Rd+(Rd/rd))/(1+Rd/rd);
20 Vo = Av*Vi;
21 Av2 = gm*Rd;
22 Vo2 = Av2*Vi;
23
24 disp(gm, 'gm(S) = ');
25 disp(rd, 'rd(ohms) = ');
26 disp(Zi, 'Zi(ohms) = ');
27 disp(Zi2, 'Zi(ohms) without rd = ');
28 disp(Zo, 'Zo(ohms) = ');
29 disp(Zo2, 'Zo(ohms) without rd = ');
30 disp(Av, 'Voltage gain Av = ');
31 disp(Vo, 'Vo = ');
```

```
32 disp(Av2, 'Volatge gain Av(ignoring rd) = ');
33 disp(Vo2, 'Vo2 witout rd = ');
```

Scilab code Exa 8.11 Network components determination

```
1 clear; clc; close;
2
3 yos = 10*10^(-6);
4 Idss = 6*10^(-3);
5 Vp = -3;
6 Vgsq = 0.35;
7 Idq = 7.6*10^(-3);
8 Rd = 1.8*10^3;
9 R1 = 10*10^6;
10 R2 = 110*10^6;
11
12
13 gmo = 2*Idss/abs(Vp);
14 gm = gmo*(1-(Vgsq/Vp));
15 rd = 1/yos;
16 Zi = R1*R2/(R1+R2);
17 Zo = rd*Rd/(Rd+rd);
18 Av = -gm*Rd;
19
20 disp(gmo, 'gmo(S) = ');
21 disp(gm, 'gm(S) = ');
22 disp(rd, 'rd(ohms) = ');
23 disp(Zi, 'Zi(ohms) = ');
24 disp(Zo, 'Zo(ohms) = ');
25 disp(Av, 'Av = ');
```

Scilab code Exa 8.12 E MOSFET components determination

```

1  clear; clc; close;
2
3  yos = 20*10(-6);
4  Vgs_on = 8;
5  Vgs_th = 3;
6  Vgsq = 6.4;
7  Idq = 2.75*10(-3);
8  Id_on = 6*10(-3);
9  k = 0.24*10(-3);
10 Rf = 10*10(6);
11 Rd = 2*10(3);
12
13 gm = 2*k*(Vgsq-Vgs_th);
14 rd = 1/yos;
15 Zi = (Rf+(rd*Rd/(rd+Rd)))/(1+gm*(rd*Rd/(rd+Rd)));
16 Zi2 = Rf/(1+gm*Rd);
17 Zo = Rf*Rd*rd/(Rf*rd+rd*Rd+Rd*Rf);
18 Zo2 = Rd;
19 Av = -gm*Rf*Rd*rd/(Rf*rd+rd*Rd+Rd*Rf);
20 Av2 = -gm*Rd;
21
22 disp(gm, 'gm(S) = ');
23 disp(rd, 'rd(ohms) = ');
24 disp(Zi, 'Zi(ohms) = ');
25 disp(Zi2, 'Zi without rd(ohms) = ');
26 disp(Zo, 'Zo(ohms) = ');
27 disp(Zo2, 'Zo without rd(ohms) = ');
28 disp(Av, 'Voltage gain Av = ');
29 disp(Av2, 'Volatge gain Av(ignoring rd) = ');

```

Scilab code Exa 8.13 Rd value determination

```

1  clear; clc; close;
2
3  yos = 30*10(-6);

```

```

4 Idss = 10*10(-3);
5 Idq = 10*10(-3);
6 Vp = -4;
7 Vgsq = 0;
8 Rg = 10*10(6);
9 Av = -15;
10 Vdd = 30;
11
12 gmo = 2*Idss/abs(Vp);
13 gm = gmo;
14 rd = 1/yos;
15
16 //let x = Rd||rd
17 x = -Av/gm;
18 Rd = 100*10(3)/30.33;//found by solving for x
19 Vdsq = Vdd-Idq*Rd;
20 Zi = Rg;
21 Zo = Rd*rd/(Rd+rd);
22
23
24 disp(Rd, 'Rd(ohms) = ');
25 disp(Zi, 'Zi(ohms) = ');
26 disp(Zo, 'Zo(ohms) = ');

```

Scilab code Exa 8.14 Rd and Rs determination

```

1 clear; clc; close;
2
3 yos = 20*10(-6);
4 Idss = 10*10(-3);
5 Idq = 10*10(-3);
6 Vp = -4;
7 Vdsq = Vp/4;
8 Rg = 10*10(6);
9 Av = -8;

```

```

10 Vdd = 20;
11
12
13 Vgsq = Vp/4;
14 Id = Idss*(1-(Vgsq/Vp))^2;
15 gmo = 2*Idss/abs(Vp);
16 gm = gmo*(1-(Vgsq/Vp));
17 //let Rd||rd = x
18 x = abs(Av)/gm;
19 rd = 1/yos;
20 Rd = 106.5*10^(3)/47.87;
21 Rs = -Vgsq/Id;
22
23 disp(Rd, 'Rd(ohms) = ');
24 disp(Rs, 'Rs(ohms) = ');

```

Scilab code Exa 8.15 Rd and Rs determination

```

1 clear; clc; close;
2
3 yos = 20*10^(-6);
4 Idss = 10*10^(-3);
5 Idq = 10*10^(-3);
6 Vp = -4;
7 Vdsq = Vp/4;
8 Rg = 10*10^(6);
9 Av = -8;
10 Vdd = 20;
11
12 Vgsq = Vp/4;
13 Id = Idss*(1-(Vgsq/Vp))^2;
14
15 Rs = -Vgsq/Id;
16
17 gmo = 2*Idss/abs(Vp);

```

```

18 gm = gmo*(1-(Vgsq/Vp));
19 Rd = -Av*(1+gm*Rs)/gm;
20
21 disp(Rs, 'Rs(ohms) = ');
22 disp(Rd, 'Rd(ohms) = ');

```

Scilab code Exa 8.16 Network characteristics determination

```

1 clear; clc; close;
2
3 yos = 20*10^(-6);
4 Idss = 10*10^(-3);
5 Idq = 2.8*10^(-3);
6 Vp = -4;
7 Vgsq = -1.9;
8 Vi = 20*10^(-3);
9 Rd = 2.4*10^3;
10 Rg = 3.3*10^6;
11 Rl = 10*10^3;
12
13 gmo = 2*Idss/abs(Vp);
14 gm = gmo*(1-(Vgsq/Vp));
15 Av2 = -gm*Rd;
16 Av1 = -gm*(Rd*Rg/(Rd+Rg));
17 Av = Av1*Av2;
18 Vo = Av*Vi;
19 Zi = Rg;
20 Zo = Rd;
21 Vl = (Rl/(Zo+Rl))*Vo;
22
23
24 disp(gm, 'gm(S) = ');
25 disp(Av2, 'voltage gain = ');
26 disp(Vo, 'output voltage(Volts) = ');
27 disp(Zi, 'input impedance(ohms) = ');

```

```
28 disp(Zo, 'output impedance(ohms) = ');
29 disp(Vl, 'output voltage across the load(Volts) = ');
```

Scilab code Exa 8.17 Input output impedance and output voltage

```
1 clear; clc; close;
2
3 Ri_stage2 = 15*(10^(3))*4.7*(10^(3))
      *1300/(15*(10^(3))*4.7*(10^(3))+4.7*(10^(3))
      *1300+15*(10^(3))*1300);
4 Rd1 = 2.4*10^(3);
5 Rd2 = 2.2*10^(3);
6 gm = 2.6*10^(-3);
7 Vi1 = 20*10^(-3);
8 Vi2 = 1*10^(-3);
9
10 Av1 = -gm*(Rd1*Ri_stage2/(Rd1+Ri_stage2));
11 Av2 = -338.46;
12 Av = Av1*Av2;
13 Vo1 = Av*Vi1;
14 Vo2 = Av*Vi2;
15 Zi = 3.3*10^(6);
16 Zo = Rd2;
17
18
19 disp(Vo2, 'Output voltage is ');
20 disp(Zi, 'Input impedance is ');
21 disp(Zo, 'Output impedance is ');
```

Chapter 9

BJT and JFET frequency response

Scilab code Exa 9.1 Log calculation

```
1 clear; clc; close;
2
3 disp(log10(10^6), 'ans for part a :- ');
4 disp(log(%e^3), 'ans for part b :- ');
5 disp(log10(10^(-2)), 'ans for part c :- ');
6 disp(log(%e^-1), 'ans for part d :- ');
```

Scilab code Exa 9.2 Log calculation

```
1 clear; clc; close;
2
3 disp(log10(64), 'ans for part a :- ');
4 disp(log(64), 'ans for part b :- ');
5 disp(log10(1600), 'ans for part c :- ');
6 disp(log10(8000), 'ans for part d :- ');
```

Scilab code Exa 9.3 Anti Log calculation

```
1 clear; clc; close;
2
3 disp(10^1.6, 'ans for part a :- ');
4 disp(%e^0.04, 'ans for part b :- ');
```

Scilab code Exa 9.4 Log calculation

```
1 clear; clc; close;
2
3 disp(log10(0.5), 'ans for part a :- ');
4 disp(log10(4000/250), 'ans for part b :- ');
5 disp(log10(0.6*30), 'ans for part c :- ');
```

Scilab code Exa 9.5 Magnitude gain calculation

```
1 clear; clc; close;
2
3 Gdb = 100;
4 Ratio_V2_by_V1 = 10^(Gdb/20);
5
6 disp(Ratio_V2_by_V1, 'Magnitude gain = ');
```

Scilab code Exa 9.6 Power and voltage gain

```

1 clear; clc; close;
2
3 Pi = 10*10^(3);
4 Po = 500;
5 Vi = 1000;
6 Ro = 20;
7
8 Gdb = 10*log10(Po/Pi);
9 Gv = 20*log10(sqrt(Po*Ro)/Vi);
10 Ri = Vi^2/Pi;
11
12 disp(Gdb, 'Power gain in decibels = ');
13 disp(Gv, 'Voltage gain in decibels = ');
14 disp(Ri, 'Ri(ohms) is ');
15 disp('which is not equal to Ro');

```

Scilab code Exa 9.7 Input power and input voltage

```

1 clear; clc; close;
2
3 Po = 40;
4 Ro = 10;
5 Gv = 40;
6 Gdb = 25;
7
8 Pi = Po/(10^(25/10));
9 disp(Pi, 'Input power in Watt = ');
10
11 Vo = sqrt(Po*Ro);
12 Vi = Vo/10^(Gv/20);
13 disp(Vi, 'Input voltage in volts = ');

```

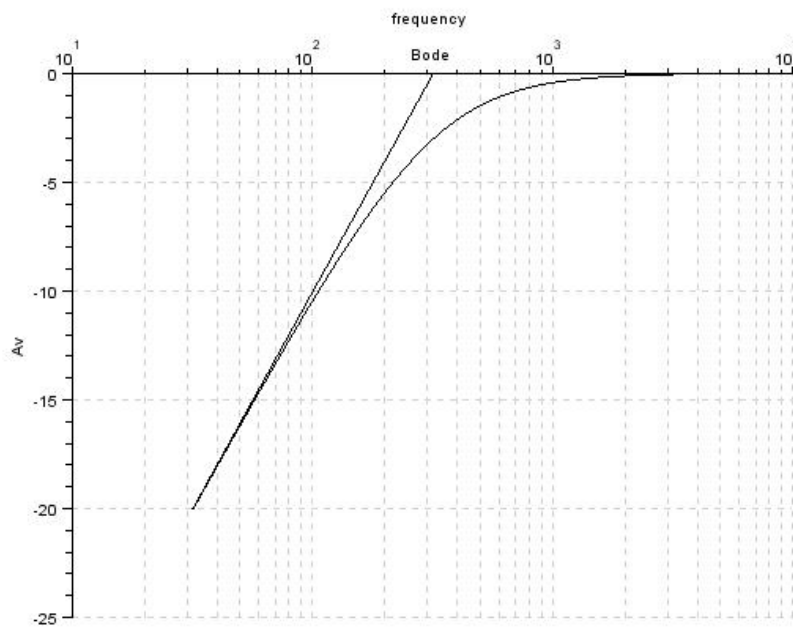

Figure 9.1: Break frequency and bode plot

Scilab code Exa 9.8 Break frequency and bode plot

```
1 clear; clc; close;
2
3 R = 5*10^(3);
4 C = 0.1*10^(-6);
5
6 f1 = 1/(2*%pi*R*C);
7 disp(f1, 'Break frequency = ');
8
9 f = 31.85:10:10*f1;
10 av = (1+(f1./f)^2)^(-1/2); // -10*log10
11 av1 = -20*log10(f1/f1);
12 f2 = f1/10;
13 av2 = -20*log10(f1/f2);
14 f3 = f1/4;
15 av3 = -20*log10(f1/f3);
16 f4 = f1/2;
17 av4 = -20*log10(f1/f4);
18
19
20 x = [f2 f3 f4 f1];
21 y = [av2 av3 av4 av1];
22
23 gainplot(f, av);
24 a = gca();
25 a.y_location = 'left';
26 a.x_location = 'top';
27 a.x_label.text = 'frequency';
28 a.y_label.text = 'Av';
29 a.title.text = 'Bode';
30 plot2d(x, y);
```

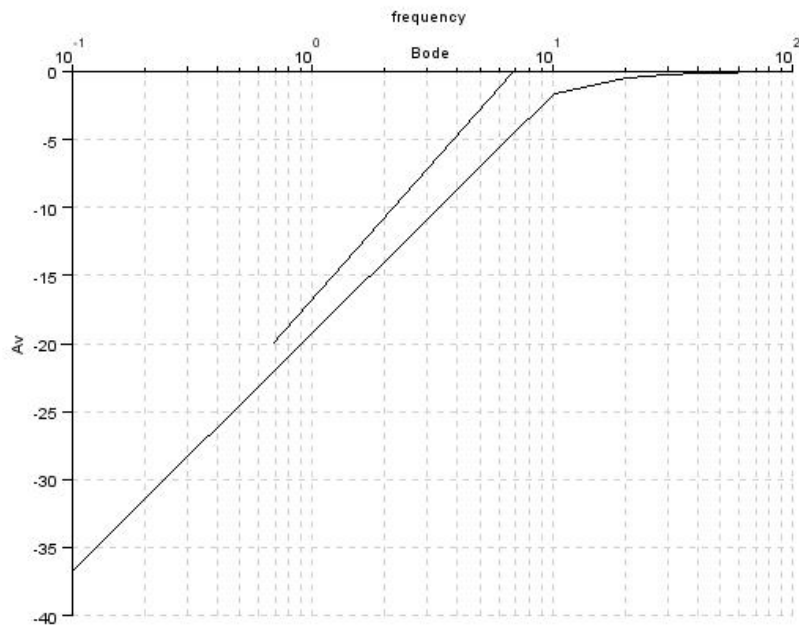

Figure 9.2: Frequency aand bode plot

Scilab code Exa 9.9 Frequency aand bode plot

```

1 clear; clc; close;
2
3 Cs = 10*10(-6);
4 Ce = 20*10(-6);
5 Cc = 1*10(-6);
6 Rs = 1*10(3);
7 R1 = 40*10(3);
8 R2 = 10*10(3);

```

```

 9 Re = 2*10^(3);
10 Rc = 4*10^(3);
11 Rl = 2.2*10^(3);
12 Beta = 100;
13 ro = %inf;
14 Vcc = 20;
15 Ve = 4-0.7;
16
17 Vb = R2*Vcc/(R2+R1);
18 Ie = Ve/Re;
19 re = 26*10^(-3)/(1.65*10^(-3));
20 x = Beta*re;
21 Av = -Rc*Rl/((Rc+Rl)*re);
22 Zi = R1*R2*x/(R1*R2+R2*x+x*R1);
23 Ri = Zi;
24 Vi_by_Vs = Ri/(Ri+Rs);
25 Avs = Av*Vi_by_Vs;
26 fls = 1/(2*%pi*(Rs+Ri)*Cs);
27 disp(fl,'Low cutoff frequency is ');
28
29 f1 = fls;
30 f = .1:10:10*f1;
31 av = (1+(f1./f)^2)^(-1/2);
32 av1 = -20*log10(f1/f1);
33 f2 = f1/10;
34 av2 = -20*log10(f1/f2);
35 f3 = f1/4;
36 av3 = -20*log10(f1/f3);
37 f4 = f1/2;
38 av4 = -20*log10(f1/f4);
39
40
41 x = [f2 f3 f4 f1];
42 y = [av2 av3 av4 av1];
43
44 gainplot(f,av);
45 a = gca();
46 a.y_location = 'left';

```

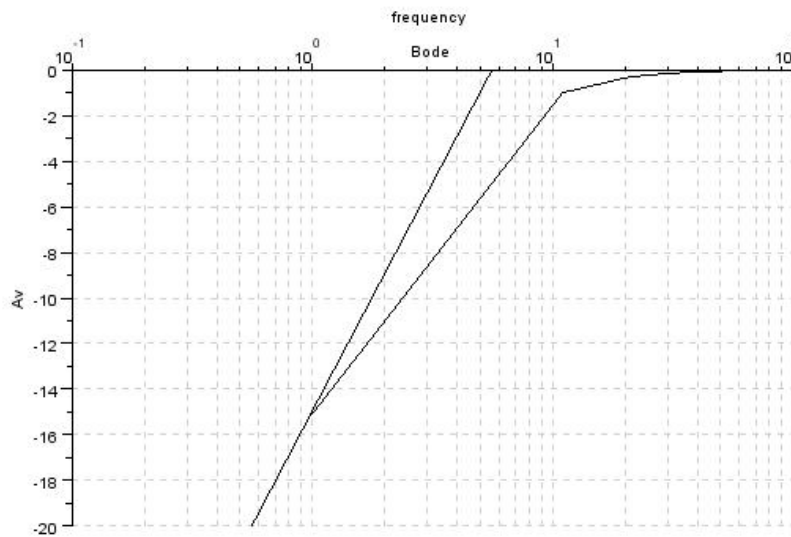

Figure 9.3: Frequency and bode plot

```

47 a.x_location = 'top';
48 a.x_label.text = 'frequency';
49 a.y_label.text = 'Av';
50 a.title.text = 'Bode';
51 plot2d(x,y);

```

Scilab code Exa 9.10 Frequency and bode plot

```

1 clear; clc; close;
2
3 Cs = 10*10^(-6);
4 Ce = 20*10^(-6);
5 Cc = 1*10^(-6);
6 Rs = 1*10^(3);

```

```

7 R1 = 40*10^(3);
8 R2 = 10*10^(3);
9 Re = 1.2*10^(3);
10 Rc = 4*10^(3);
11 Rl = 10*10^(3);
12 Beta = 100;
13 ro = %inf;
14 Vcc = 10;
15 Ve = 2-0.7;
16
17 Vb = R2*Vcc/(R2+R1);
18 Ie = Ve/Re;
19 re = 26*10^(-3)/(1.083*10^(-3));
20 x = Beta*re;
21 Av = -Rc*Rl/((Rc+Rl)*re);
22 Zi = R1*R2*x/(R1*R2+R2*x+x*R1);
23 Ri = Zi;
24 Vi_by_Vs = Ri/(Ri+Rs);
25 Avs = Av*Vi_by_Vs;
26 fls = 1/(2*pi*(Rs+Ri)*Cs);
27 disp(fl,'Low cutoff frequency is ');
28
29 f1 = fls;
30 f = 1:10:10*f1;
31 av = (1+(f1./f)^2)^(-1/2);
32 av1 = -20*log10(f1/f1);
33 f2 = f1/10;
34 av2 = -20*log10(f1/f2);
35 f3 = f1/4;
36 av3 = -20*log10(f1/f3);
37 f4 = f1/2;
38 av4 = -20*log10(f1/f4);
39
40
41 x = [f2 f3 f4 f1];
42 y = [av2 av3 av4 av1];
43
44 gainplot(f,av);

```

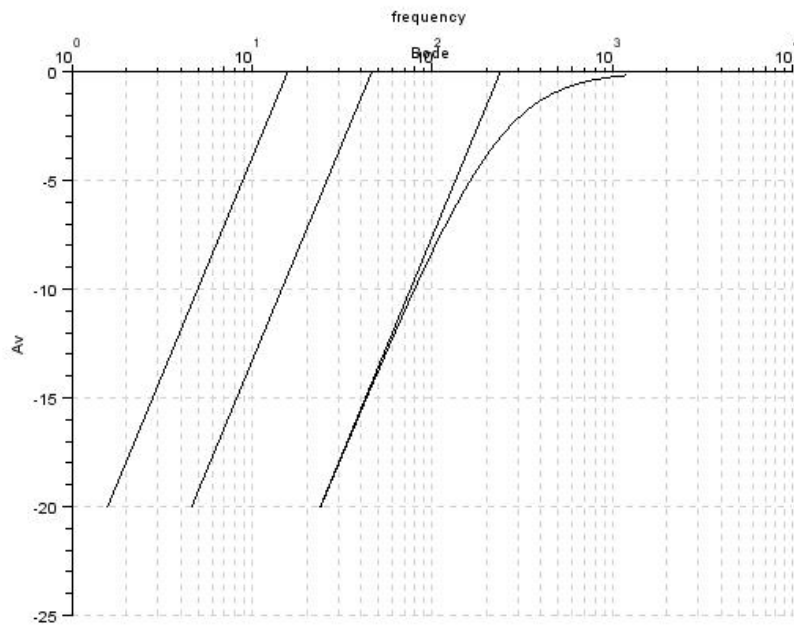



Figure 9.4: Frequency and bode plot

```

45 a = gca();
46 a.y_location = 'left';
47 a.x_location = 'top';
48 a.x_label.text = 'frequency';
49 a.y_label.text = 'Av';
50 a.title.text = 'Bode';
51 plot2d(x,y);

```

Scilab code Exa 9.11 Frequency and bode plot

```

1 clear; clc; close;

```

```

2
3 Cs = 2*10(-6);
4 Cg = 0.01*10(-6);
5 Cc = 0.5*10(-6);
6 Rs = 1*10(3);
7 Rg = 1*10(6);
8 Rsig = 10*10(3);
9 Rd = 4.7*10(3);
10 Rl = 2.2*10(3);
11
12 Idss = 8*10(-3);
13 Vp = -4;
14 rd = %inf;
15 Vdd = 20;
16
17 Vgsq = -2;
18 Idq = 2*10(-3);
19 gmo = 2*Idss/abs(Vp);
20 gm = gmo*(1-(Vgsq/Vp));
21 flg = 1/(2*%pi*(Rsig+Rg)*Cg);
22 flc = 1/(2*%pi*(Rd+Rl)*Cc);
23 Req = Rs*(1/gm)/(Rs+(1/gm));
24 fls = 1/(2*%pi*Req*Cs);
25 Avmid = -gm*(Rd*Rl/(Rd+Rl));
26
27 disp(fl_s, 'Lowest frequency cutoff = ');
28 disp(Avmid, 'midband gain = ');
29
30 f1 = fls;
31 f = .1*f1:10:5*f1;
32 av = (1+(f1./f)^2)(-1/2);
33 av1 = -20*log10(f1/f1);
34 f2 = f1/10;
35 av2 = -20*log10(f1/f2);
36 f3 = f1/4;
37 av3 = -20*log10(f1/f3);
38 f4 = f1/2;
39 av4 = -20*log10(f1/f4);

```

```

40
41 x = [f2 f3 f4 f1];
42 y = [av2 av3 av4 av1];
43
44 gainplot(f,av);
45 a = gca();
46 a.y_location = 'left';
47 a.x_location = 'top';
48 a.x_label.text = 'frequency';
49 a.y_label.text = 'Av';
50 a.title.text = 'Bode';
51 plot2d(x,y);
52
53
54 f1 = flg;
55 //f = .1*f1:10:10*f1;
56 av = -10*log10(1+(f1./f)^2);
57 av1 = -20*log10(f1/f1);
58 f2 = f1/10;
59 av2 = -20*log10(f1/f2);
60 f3 = f1/4;
61 av3 = -20*log10(f1/f3);
62 f4 = f1/2;
63 av4 = -20*log10(f1/f4);
64
65 x = [f2 f3 f4 f1];
66 y = [av2 av3 av4 av1];
67
68 plot2d(x,y);
69
70 f1 = flc;
71 //f = .1*f1:10:10*f1;
72 av = -10*log10(1+(f1./f)^2);
73 av1 = -20*log10(f1/f1);
74 f2 = f1/10;
75 av2 = -20*log10(f1/f2);
76 f3 = f1/4;
77 av3 = -20*log10(f1/f3);

```

```

78 f4 = f1/2;
79 av4 = -20*log10(f1/f4);
80
81 x = [f2 f3 f4 f1];
82 y = [av2 av3 av4 av1];
83 plot2d(x,y);

```

Scilab code Exa 9.12 Frequency

```

1 clear; clc; close;
2
3 Cs = 10*10^(-6);
4 Ce = 20*10^(-6);
5 Cc = 1*10^(-6);
6 Rs = 1*10^3;
7 R1 = 40*10^3;
8 R2 = 10*10^3;
9 Re = 2*10^3;
10 Rc = 4*10^3;
11 Rl = 2.2*10^3;
12 Beta = 100;
13 ro = %inf;
14 re = 15.76;
15 Vcc = 20;
16 Ve = 4-0.7;
17 Cwo = 8*10^(-12);
18 Cwi = 6*10^(-12);
19 Cce = 1*10^(-12);
20 Cbc = 4*10^(-12);
21 Cbe = 36*10^(-12);
22 fls = 6.86;
23
24 Ri = 1.32*10^3;
25 Avmid = -90;
26 Rthi = Rs*R1*R2*Ri/(Rs*R1*R2+R1*R2*Ri+R2*Ri*Rs+Ri*Rs

```

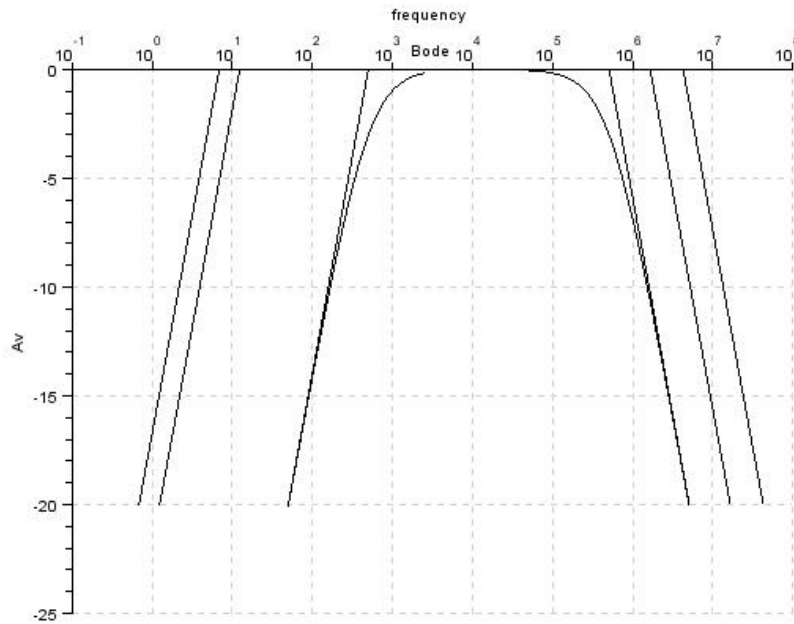

Figure 9.5: Frequency and bode plot

```

    *R1);
27 Ci = Cwi+Cbe+(1-Avmid)*Cbc;
28 fhi = 1/(2*pi*Rthi*Ci);
29 Rtho = Rc*Rl/(Rc+Rl);
30 Co = Cwo+Cce+(1-(1/Avmid))*Cbc;
31 fho = 1/(2*pi*Rtho*Co);
32 fbeta = 1/(2*pi*Beta*re*(Cbe+Cbc));
33 ft = Beta*fbeta;
34 disp(fhi, 'fhi = ');
35 disp(fho, 'fho = ');
36 disp(fbeta, 'fbeta = ');
37 disp(ft, 'ft = ');

```

Scilab code Exa 9.13 Frequency and bode plot

```
1 clear; clc; close;
2
3 Cs = 10*10^(-6);
4 Ce = 20*10^(-6);
5 Cc = 1*10^(-6);
6 Rs = 1*10^3;
7 R1 = 40*10^3;
8 R2 = 10*10^3;
9 Re = 1.2*10^3;
10 Rc = 4*10^3;
11 Rl = 10*10^3;
12 Beta = 100;
13 ro = %inf;
14 re = 24.01;
15 Vcc = 10;
16 Ve = 2-0.7;
17 Cwo = 8*10^(-12);
18 Cwi = 6*10^(-12);
19 Cce = 1*10^(-12);
20 Cbc = 4*10^(-12);
21 Cbe = 36*10^(-12);
22 fls = 6.86;
23
24 Ri = 1.85*10^3;
25 Avmid = -119;
26 Rthi = Rs*R1*R2*Ri/(Rs*R1*R2+R1*R2*Ri+R2*Ri*Rs+Ri*Rs
    *R1);
27 Ci = Cwi+Cbe+(1-Avmid)*Cbc;
28 fhi = 1/(2*pi*Rthi*Ci);
29 Rtho = Rc*Rl/(Rc+Rl);
30 Co = Cwo+Cce+(1-(1/Avmid))*Cbc;
31 fho = 1/(2*pi*Rtho*Co);
```

```

32 fpie = 1/(2*%pi*Beta*re*(Cbe+Cbc));
33 ft = Beta*fpie;
34
35 disp(fhi, 'fhi = ');
36 disp(fho, 'fho = ');
37 disp(fpie, 'fbeta = ');
38 disp(ft, 'ft = ');
39 fle = 500;
40 flc = 1/(2*%pi*(Rl+Rtho)*Cc);
41
42 f1 = fle;
43 f = 0.1*f1:100:10*f1;
44 av = (1+(f1./f)^2)^(-1/2);
45 av1 = -20*log10(f1/f1);
46 f2 = f1/10;
47 av2 = -20*log10(f1/f2);
48 f3 = f1/4;
49 av3 = -20*log10(f1/f3);
50 f4 = f1/2;
51 av4 = -20*log10(f1/f4);
52
53 x = [f2 f3 f4 f1];
54 y = [av2 av3 av4 av1];
55
56 gainplot(f, av);
57 a = gca();
58 a.y_location = 'left';
59 a.x_location = 'top';
60 a.x_label.text = 'frequency';
61 a.y_label.text = 'Av';
62 a.title.text = 'Bode';
63 plot2d(x, y);
64
65
66 f1 = fls;
67 //f = .1*f1:10:10*f1;
68 av = -10*log10(1+(f1./f)^2);
69 av1 = -20*log10(f1/f1);

```

```

70 f2 = f1/10;
71 av2 = -20*log10(f1/f2);
72 f3 = f1/4;
73 av3 = -20*log10(f1/f3);
74 f4 = f1/2;
75 av4 = -20*log10(f1/f4);
76
77 x = [f2 f3 f4 f1];
78 y = [av2 av3 av4 av1];
79 plot2d(x,y);
80
81
82 f1 = flc;
83 //f = .1*f1:10:10*f1;
84 av = -10*log10(1+(f1./f)^2);
85 av1 = -20*log10(f1/f1);
86 f2 = f1/10;
87 av2 = -20*log10(f1/f2);
88 f3 = f1/4;
89 av3 = -20*log10(f1/f3);
90 f4 = f1/2;
91 av4 = -20*log10(f1/f4);
92
93 x = [f2 f3 f4 f1];
94 y = [av2 av3 av4 av1];
95 plot2d(x,y);
96
97 f1 = fhi;
98 f = 0.1*f1:100:10*f1;
99 av = (1+(f/f1)^2)^(-1/2);
100 av1 = -20*log10(f1/f1);
101 f2 = f1*10;
102 av2 = -20*log10(f2/f1);
103 f3 = f1*4;
104 av3 = -20*log10(f3/f1);
105 f4 = f1*2;
106 av4 = -20*log10(f4/f1);
107

```



```
108 x = [f1 f4 f3 f2];
109 y = [av1 av4 av3 av2];
110
111 gainplot(f,av);
112 plot2d(x,y);
113
114
115 f1 = fpie;
116 av1 = -20*log10(f1/f1);
117 f2 = f1*10;
118 av2 = -20*log10(f2/f1);
119 f3 = f1*4;
120 av3 = -20*log10(f3/f1);
121 f4 = f1*2;
122 av4 = -20*log10(f4/f1);
123
124 x = [f1 f4 f3 f2];
125 y = [av1 av4 av3 av2];
126
127 plot2d(x,y);
128
129
130 f1 = fho;
131 av1 = -20*log10(f1/f1);
132 f2 = f1*10;
133 av2 = -20*log10(f2/f1);
134 f3 = f1*4;
135 av3 = -20*log10(f3/f1);
136 f4 = f1*2;
137 av4 = -20*log10(f4/f1);
138
139 x = [f1 f4 f3 f2];
140 y = [av1 av4 av3 av2];
141
142 plot2d(x,y);
```

Scilab code Exa 9.14 Frequency

```
1 clear; clc; close;
2
3 Cs = 2*10^(-6);
4 Cg = 0.01*10^(-6);
5 Cc = 0.5*10^(-6);
6 Rs = 1*10^(3);
7 Rg = 1*10^(6);
8 Rsig = 10*10^(3);
9 Rd = 4.7*10^(3);
10 Rl = 2.2*10^(3);
11 Idss = 8*10^(-3);
12 Vp = -4;
13 rd = %inf;
14 Vdd = 20;
15 Cgd = 2*10^(-12);
16 Cgs = 4*10^(-12);
17 Cds = 0.5*10^(-12);
18 Cwi = 5*10^(-12);
19 Cwo = 6*10^(-12);
20
21
22 Rthi = Rsig*Rg/(Rsig+Rg);
23 Av = -3;
24 Ci = Cwi+Cgs+(1-Av)*Cgd;
25 fhi = 1/(2*%pi*Rthi*Ci);
26 Rtho = Rd*Rl/(Rd+Rl);
27 Co = Cwo+Cds+(1-(1/Av))*Cgd;
28 fho = 1/(2*%pi*Rtho*Co);
29
30 disp(fhi, 'fhi = ');
31 disp(fho, 'fho = ');
```

Scilab code Exa 9.15 Fourier transform and time

```
1 clear; clc; close;
2
3 V = 50*10(-3);
4 V_bar = 40*10(-3);
5 fs = 5*10(3);
6
7 vi = (4*10(-3)/%pi)*(sin(2*%pi*5*10(3)*%t)+(1/3)*
      sin(2*%pi*15*10(3)*%t)+(1/5)*sin(2*%pi*25*10(3)
      *%t)+(1/7)*sin(2*%pi*35*10(3)*%t)+(1/9)*sin(2*
      %pi*45*10(3)*%t));
8
9 tr = (18-2)*10(-6);
10 BW = 0.35/tr;
11 P = (V-V_bar)/V;
12 flo = (P/%pi)*fs;
13
14 disp(BW, 'Bandwidth is ');
15 disp(flo, 'Low cutoff frequency = ');
```

Chapter 10

Operational Amplifiers

Scilab code Exa 10.1 Dc voltages and currents calculation

```
1 clear; clc; close;
2
3 Vcc = 9;
4 Vee = Vcc;
5 Rc = 3.9*10^(3);
6 Re = 3.3*10^(3);
7
8
9 Ie = (Vee-0.7)/Re;
10 Ic = Ie/2;
11 Vc = Vcc-Ic*Rc;
12
13 disp(Ie, 'Emitter current (Amperes) = ');
14 disp(Ic, 'Collector current (Amperes) = ');
15 disp(Vc, 'Collector voltage (Volts) = ');
```

Scilab code Exa 10.2 Single ended output voltage

```

1 clear; clc; close;
2
3 Vcc = 9;
4 Vee = Vcc;
5 Vi = 2*10(-3);
6 Rc = 47*10(3);
7 Re = 43*10(3);
8
9
10 Ie = (Vee-0.7)/Re;
11 Ic = Ie/2;
12 Vc = Vcc-Ic*Rc;
13 re = 26/0.0965;
14 Av = Rc/(2*re);
15 Vo = Av*Vi;
16
17 disp(Vo, 'Single ended output voltage (Volts) = ');

```

Scilab code Exa 10.3 Common mode gain

```

1 clear; clc; close;
2
3 Beta = 75;
4 Rc = 47*10(3);
5 ri = 20*10(3);
6 Re = 43*10(3);
7
8 Ac = Beta*Rc/(ri+2*(Beta+1)*Re);
9
10 disp(Ac, 'Common mode gain = ');

```

Scilab code Exa 10.4 Common mode gain

```
1 clear; clc; close;
2
3 Beta = 75;
4 Rc = 10*10^(3);
5 ri = 11*10^(3);
6 Re = 200*10^(3);
7 ro = 200*10^(3);
8
9 Re = ro;
10 Ac = Beta*Rc/(ri+2*(Beta+1)*Re);
11
12 disp(Ac, 'Common mode gain = ');
```

Scilab code Exa 10.5 Output voltage

```
1 clear; clc; close;
2
3 Rf = 500*10^(3);
4 R1 = 100*10^(3);
5 V1 = 2;
6
7 Vo = -(Rf/R1)*V1;
8
9 disp(Vo, 'Output voltage (Volts) = ');
```

Scilab code Exa 10.6 Output voltage

```
1 clear; clc; close;
2
3 Rf = 500*10^(3);
4 R1 = 100*10^(3);
5 V1 = 2;
6
```

```
7 Vo = (1+(Rf/R1))*V1;  
8  
9 disp(Vo, 'Output voltage (Volts) = ');
```

Scilab code Exa 10.7 Output voltage

```
1 clear; clc; close;  
2  
3 //part a  
4  
5 V1 = 1;  
6 V2 = 2;  
7 V3 = 3;  
8 R1 = 500*10^(3);  
9 R2 = 1*10^(6);  
10 R3 = 1*10^(6);  
11 Rf = 1000*10^(3);  
12  
13 Vo = -((Rf/R1)*V1+(Rf/R2)*V2+(Rf/R3)*V3);  
14 disp(Vo, 'Output voltage (Volts) = ');  
15  
16 //part b  
17  
18  
19 V1 = -2;  
20 V2 = 3;  
21 V3 = 1;  
22 R1 = 200*10^(3);  
23 R2 = 500*10^(3);  
24 R3 = 1*10^(6);  
25 Rf = 1000*10^(3);  
26  
27 Vo = -((Rf/R1)*V1+(Rf/R2)*V2+(Rf/R3)*V3);  
28 disp(Vo, 'Output voltage (Volts) = ');
```

Scilab code Exa 10.8 Output offset voltage

```
1 clear; clc; close;
2
3 Vio = 1.2*10^(-3);
4 R1 = 2*10^3;
5 Rf = 150*10^3;
6
7 Vo = Vio*((R1+Rf)/R1);
8 disp(Vo, 'Output offset voltage (Volts) = ');
```

Scilab code Exa 10.9 Output offset voltage

```
1 clear; clc; close;
2
3 Iio = 100*10^(-9);
4 Rf = 150*10^3;
5
6 Vo = Iio*Rf;
7 disp(Vo, 'Output offset voltage (Volts) = ');
```

Scilab code Exa 10.10 Total offset voltage

```
1 clear; clc; close;
2
3 Iio = 150*10^(-9);
4 Rf = 500*10^3;
5 R1 = 5*10^3;
6 Vio = 4*10^(-3);
```



```

7
8 Vo_vio = Vio*(R1+Rf)/R1;
9 Vo_io = Iio*Rf;
10 Vo = Vo_vio+Vo_io;
11
12 disp(Vo, 'Total voltage offset (Volts) = ');

```

Scilab code Exa 10.11 Input bias current

```

1 clear; clc; close;
2
3 Iio = 5*10^(-9);
4 Iib = 30*10^(-9);
5
6 Iib_positive = Iib + Iio/2;
7 Iib_negative = Iib -Iio/2;
8
9 disp(Iib_positive, 'Positive input bias current (
    Amperes) = ');
10 disp(Iib_negative, 'Negative input bias current (
    Amperes) = ');

```

Scilab code Exa 10.12 Cut off frequency

```

1 clear; clc; close;
2
3 B1 = 1*10^(6);
4 Avd = 200*10^(3); //converting from V/mV
5
6 f1 = B1;
7 fc = f1/Avd;
8
9 disp(fc, 'Cutoff frequency (Hertz) = ')

```

Scilab code Exa 10.13 Maximum closed loop voltage gain

```
1 clear; clc; close;
2
3 SR = 2;
4 Vi_delta = 0.5;
5 t_delta = 10;
6
7 Acl = SR/(Vi_delta/t_delta);
8
9 disp(Acl, 'Maximum Closed loop voltage gain = ');
```

Scilab code Exa 10.14 Maximum frequency

```
1 clear; clc; close;
2
3 Rf = 240*10^(3);
4 R1 = 10*10^(3);
5 Vi = 0.02;
6 w = 300*10^(3);
7 SR = 0.5;
8
9 Acl = abs(Rf/R1);
10 K = Acl*Vi;
11 w1 = SR/K;
12
13 disp(w, 'Since this frequency is much less than
    maximum obtained, hence no distortion will be
    observed');
```

Scilab code Exa 10.15 Current drawn calculation

```
1 clear; clc; close;
2
3 V = 12;
4 P = 250*10(-3);
5
6 I = P/V;
7
8 disp(I, 'Current drawn(Amperes) = ');
```

Scilab code Exa 10.16 Output offset voltage

```
1 clear; clc; close;
2
3 Rf = 360*10(3);
4 R1 = 12*10(3);
5 Iio = 20*10(-9);
6 Vio = 1*10(-3);
7
8 Vo_vio = Vio*(R1+Rf)/R1;
9 Vo_iio = Iio*Rf;
10 Vo = Vo_vio + Vo_iio;
11
12 disp(Vo, 'Output offset voltage(Volts) = ');
```

Scilab code Exa 10.17 Gain and input output impedance calculation

```
1 clear; clc; close;
2
3 Rf = 360*10(3);
4 R1 = 12*10(3);
5 ro = 75;
```

```

6 A = 200*10^(3);
7 Beta = 1/30;
8
9 Acl = -Rf/R1;
10 Zi = R1;
11 Zo = ro/(1+Beta*A)
12
13 disp(Acl, 'Acl = ');
14 disp(Zi, 'Zi (Ohms) = ');
15 disp(Zo, 'Zo (Ohms) = ');

```

Scilab code Exa 10.18 Cut off frequency

```

1 clear; clc; close;
2
3 B1 = 1*10^(6);
4 Avd = 20*10^3;
5
6 f1 = B1;
7 fc = f1/Avd;
8
9
10 disp(fc, 'Cutoff frequency (Hertz) = ');

```

Scilab code Exa 10.19 Maximum frequency

```

1 clear; clc; close;
2
3 Vi = 25*10^(-3);
4 Acl = 30;
5 SR = 0.5*10^6; //convertin from us to s
6
7 K = Acl*Vi;

```

```
8 fmax = SR/(2*%pi*K);
9
10 disp(fmax, 'Maximum frequency (Hertz) = ');
```

Scilab code Exa 10.20 Open loop voltage gain

```
1 clear; clc; close;
2
3 Avd_db = 104;
4 Avd = 10^(104/20);
5
6 disp(Avd, 'Open loop voltage gain (Volts) = ');
```

Scilab code Exa 10.21 CMRR calculation

```
1 clear; clc; close;
2
3 Vo = 8;
4 Vo_1 = 12*10^(-3);
5 Vd = 1*10^(-3);
6 Vc = 1*10^(-3);
7
8
9 Ad = Vo/Vd;
10 Ac = Vo_1/Vc;
11 CMRR = Ad/Ac;
12 CMRR = 20*log10(Ad/Ac);
13
14 disp(CMRR, 'CMRR(dB) = ');
```

Scilab code Exa 10.22 Output voltage

```
1 clear; clc; close;
2
3 Vi1 = 150*10^(-6);
4 Vi2 = 140*10^(-6);
5 Ad = 4000;
6
7 //part a
8 CMRR = 100;
9
10 Vd = Vi1 - Vi2;
11 Vc = 1/2*(Vi1+Vi2);
12 Vo = Ad*Vd*(1+(1/CMRR)*(Vc/Vd));
13 disp(Vo, 'Output voltage (Volts) = ');
14
15
16 //part b
17
18 CMRR = 100000;
19
20 Vd = Vi1 - Vi2;
21 Vc = 1/2*(Vi1+Vi2);
22 Vo = Ad*Vd*(1+(1/CMRR)*(Vc/Vd));
23 disp(Vo, 'Output voltage (Volts) = ');
```

Chapter 11

Op Amp Applications

Scilab code Exa 11.1 Output voltage

```
1 clear; clc; close;
2
3 Rf = 200*10^(3);
4 R1 = 2*10^(3);
5 Vi = 2.5*10^(-3);
6
7 A = -Rf/R1;
8 Vo = A*Vi;
9
10 disp(Vo, 'Output voltage (Volts) = ');
```

Scilab code Exa 11.2 Output voltage

```
1 clear; clc; close;
2
3 Rf = 240*10^(3);
4 R1 = 2.4*10^(3);
5 Vi = 120*10^(-6);
```

```
6
7 A = 1+(Rf/R1);
8 Vo = A*Vi;
9
10 disp(Vo, 'Output voltage (Volts) = ');
```

Scilab code Exa 11.3 Output voltage

```
1 clear; clc; close;
2
3 Rf = 470*10^(3);
4 R1 = 4.3*10^(3);
5 R2 = 33*10^(3);
6 R3 = 33*10^(3);
7
8 Vi = 80*10^(-6);
9
10 A = ((1+(Rf/R1))*(-Rf/R2))*(-Rf/R3));
11 Vo = A*Vi;
12
13 disp(Vo, 'Output voltage (Volts) = ');
```

Scilab code Exa 11.4 Output voltage

```
1 clear; clc; close;
2
3 Rf = 270*10^(3);
4 A1 = 10;
5 A2 = -18;
6 A3 = -27;
7 Vi = 150*10^(-6);
```

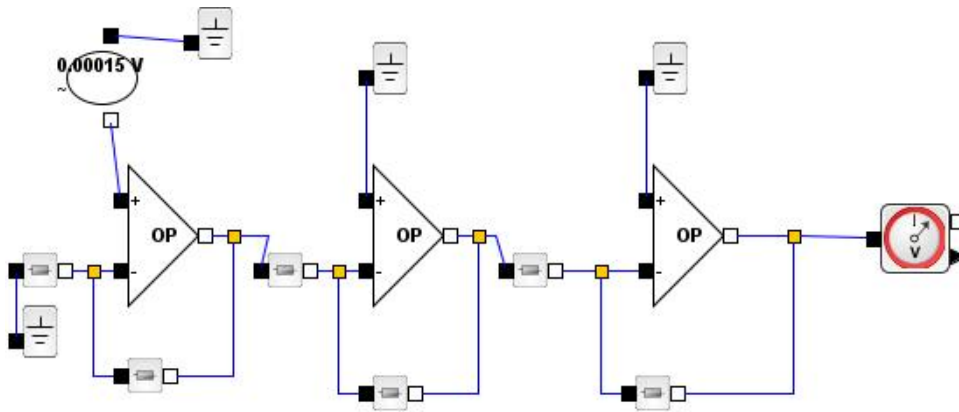



Figure 11.1: Output voltage

```

8
9
10 R1 = Rf / (A1 - 1);
11 R2 = Rf / -A2;
12 R3 = Rf / -A3;
13
14 Vo = A1 * A2 * A3 * Vi;
15
16 disp(Vo, 'Output voltage (Volts) = ');

```

Scilab code Exa 11.5 Connection of op amp stages

```

1 clear; clc; close;
2
3 Rf = 500 * 10^3;
4 A1 = -10;
5 A2 = -20;
6 A3 = -50;
7

```

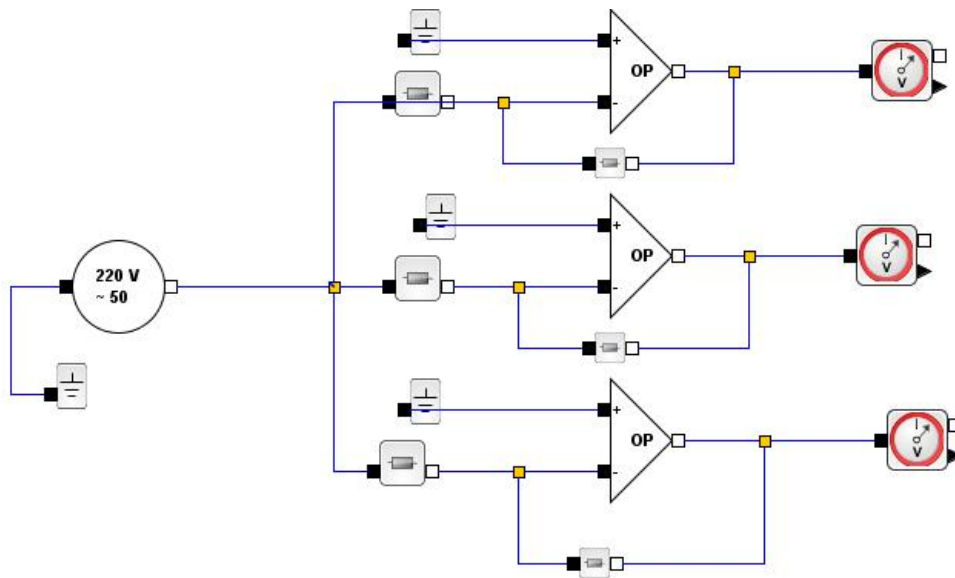

Figure 11.2: Connection of op amp stages

```

8 R1 = -Rf/A1;
9 R2 = -Rf/A2;
10 R3 = -Rf/A3;
11
12
13 disp(R1, 'R1(ohms) = ');
14 disp(R2, 'R2(ohms) = ');
15 disp(R3, 'R3(ohms) = ');

```

Scilab code Exa 11.6 Output voltage

```

1 clear; clc; close;
2
3 v1 = ["*sin(1000t)"];
4 v2 = ["*sin(3000t)"];
5

```

```

6 Vo = strcat([string(-(330*10^3)/(33*10^3)*50*10^(-3)
    ),v1,string(-(330*10^3)/(10*10^3)*10^(-3)),v2]);
7
8 disp(Vo,'Output voltage (Volts) = ');

```

Scilab code Exa 11.7 Output voltage

```

1 clear; clc; close;
2
3 Rf = 1*10^(6);
4 R1 = 100*10^(3);
5 R2 = 50*10^(3);
6 R3 = 500*10^(3);
7
8 v2 = ["*V2"];
9 v1 = ["*V1"];
10 Vo = strcat([string((-Rf/R2)),v2,"+",string((Rf/R3)
    *(Rf/R1)),v1]);
11
12 disp(Vo,'Output voltage = ');

```

Scilab code Exa 11.8 Output voltage

```

1 clear; clc; close;
2
3 Vo = strcat([ string((20/(20+20)) * ((100+100)/100))
    ,"*V1",string(-(100*10^3)/(100*10^3)),"*V2"]);
4
5 disp(Vo,'Output voltage = ');

```

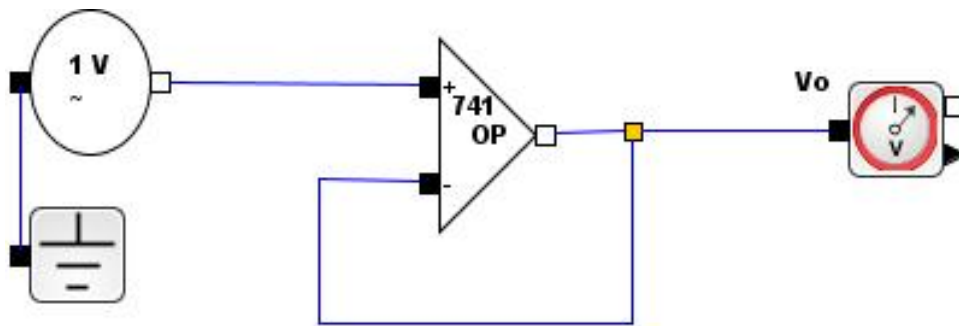

Figure 11.3: Connection of unity gain ckt

This code can be downloaded from the website www.scilab.in

Scilab code Exa 11.10 I_1 and V_o calculation

```

1  clear; clc; close;
2
3  V1 = 8;
4  R1 = 2*10^3;
5  I1 = 10*10^(-3);
6
7
8  I1 = V1/R1;
9  Vo = -I1*R1;
10
11 disp(I1, 'I1 (Amperes) = ');
12 disp(Vo, 'Vo (Volts) = ');

```

Scilab code Exa 11.11 Output voltage

```

1 clear; clc; close;
2
3 R = 5000;
4 Rp = 500;
5
6
7 a = ['*(V1-V2)'];
8 Vo = strcat([string((1+(2*R/Rp))),a]);
9
10 disp(Vo, 'Output voltage ');

```

Scilab code Exa 11.12 Cut off frequency

```

1 clear; clc; close;
2
3 R1 = 1.2*10^(3);
4 C1 = 0.02*10^(-6);
5
6 foh = 1/(2*%pi*R1*C1);
7
8 disp(foh, 'Cutoff frequency of low pass filter (Hertz)
    = ');

```

Scilab code Exa 11.13 Cut off frequency of high pass filter

```

1 clear; clc; close;
2
3 Rf = 50*10^(3);
4 Rg = 10*10^(3);
5 R1 = 2.1*10^(3);
6 C1 = 0.05*10^(-6);
7
8 Av = 1+(Rf/Rg);

```

```
9 fol = 1/(2*%pi*R1*C1);
10
11 disp(fol, 'Cutoff frequency of second order high pass
    filter (Hertz) = ');
```

Scilab code Exa 11.14 Cut off frequency of band pass filter

```
1 clear; clc; close;
2
3 R1 = 10*10^(3);
4 R2 = 10*10^(3);
5 C1 = 0.1*10^(-6);
6 C2 = 0.002*10^(-6);
7
8
9 fol = 1/(2*%pi*R1*C1);
10 foh = 1/(2*%pi*R2*C2);
11
12 disp(fol, 'Low Cutoff frequency of band pass filter(
    hertz) = ');
13 disp(foh, 'High Cutoff frequency of band pass filter(
    hertz) = ');
```

Chapter 12

Power Amplifiers

Scilab code Exa 12.1 input output power and efficiency

```
1 clear; clc; close;
2
3 Vcc = 20;
4 Rb = 1*10^(3);
5 Rc = 20;
6 Beta = 25;
7 Ib_p = 10*10^(-3);
8
9
10 Ibq = (Vcc-0.7)/Rb;
11 Ib = Ibq;
12 Icq = Beta*Ibq;
13 Ic = Icq;
14 Vceq = Vcc-Ic*Rc;
15 Ic_p = Beta*Ib_p;
16 Po_ac = (Ic_p^2)*Rc/2;
17 Pi_dc = Vcc*Icq;
18 n = (Po_ac/Pi_dc)*100;
19
20 disp(Po_ac, 'Output power = ');
21 disp(Pi_dc, 'Input power = ');
```

```
22 disp(n, 'Efficiency in percentage = ');
```

Scilab code Exa 12.2 Effective Resistance

```
1 clear; clc; close;
2
3 a = 15;
4 R1 = 8;
5
6 R1_dash = (a^2)*R1;
7
8 disp(R1_dash, 'Effective resistance looking into
   primary transformer is ');
```

Scilab code Exa 12.3 Turns ratio

```
1 clear; clc; close;
2
3 R1_dash = 10*10^(3);
4 R1 = 8;
5
6 N1_N2 = sqrt(R1_dash/R1);
7
8 disp(N1_N2, 'Turns ratio = ');
```

Scilab code Exa 12.4 Ac power delivered

```
1 clear; clc; close;
2
3 Vcc = 10;
```



```

4 a = 3;
5 Rl = 8;
6
7
8 Vceq = Vcc;
9 Vce = Vceq;
10 Icq = 140*10(-3);
11
12 Rl_dash = (a2)*Rl;
13 Ic = Vce/Rl_dash;
14
15 Vce_min = 1.7;
16 Vce_max = 18.3;
17 Ic_min = 25*10(-3);
18 Ic_max = 255*10(-3);
19
20 Po_ac = (Vce_max-Vce_min)*(Ic_max-Ic_min)/8;
21
22 disp(Po_ac, 'Ac Power delivered (Watts) = ');

```

Scilab code Exa 12.5 input and dissipated power and efficiency

```

1 clear; clc; close;
2
3 Vcc = 10;
4 Icq = 140*10(-3);
5 Po_ac = 0.477;
6
7
8 Pi_dc = Vcc*Icq;
9 Pq = Pi_dc-Po_ac;
10 n = (Po_ac/Pi_dc)*100;
11
12 disp(Pi_dc, 'Dc input power (Watts) = ');
13 disp(Pq, 'Power dissipated by transistor (Watts) = ');

```

```
14 disp(n, 'Efficiency (Percentage) = ');
```

Scilab code Exa 12.6 Efficiency calculation

```
1 clear; clc; close;
2
3 Vcc = 12;
4
5 //part a
6 V_p = 12;
7 Vceq = Vcc;
8 Vce_max = Vceq + V_p;
9 Vce_min = Vceq - V_p;
10
11 n = 50*((Vce_max-Vce_min)/(Vce_max+Vce_min))^2;
12
13 disp(n, 'Efficiency (Percentage) = ');
14
15 //part b
16 V_p = 6;
17 Vceq = Vcc;
18 Vce_max = Vceq + V_p;
19 Vce_min = Vceq - V_p;
20
21 n = 50*((Vce_max-Vce_min)/(Vce_max+Vce_min))^2;
22
23 disp(n, 'Efficiency (Percentage) = ');
24
25
26 //part c
27 V_p = 8;
28 Vceq = Vcc;
29 Vce_max = Vceq + V_p;
30 Vce_min = Vceq - V_p;
31
```

```
32 n = 50*((Vce_max-Vce_min)/(Vce_max+Vce_min))^2;
33
34 disp(n, 'Efficiency (Percentage) = ');
```

Scilab code Exa 12.7 Input output power and efficiency

```
1 clear; clc; close;
2
3 V1_p = 20;
4 Vcc = 30;
5 R1 = 16;
6
7
8 I1_p = V1_p/R1;
9 Idc = (2/%pi)*I1_p;
10 Pi_dc = Vcc*Idc;
11 Po_ac = ((V1_p)^2)/(2*R1);
12 n = (Po_ac/Pi_dc)*100;
13
14
15 disp(Pi_dc, 'Input power (Watts) = ');
16 disp(Po_ac, 'Output power (Watts) = ');
17 disp(n, 'Efficiency (Percentage) = ');
```

Scilab code Exa 12.8 Power and transmission dissipation

```
1 clear; clc; close;
2
3 Vcc = 30;
4 R1 = 16;
5
6
7 Po_max = (Vcc^2)/(2*R1);
```

```

8 Pi_max = (2*Vcc^2)/(%pi*Rl);
9 n_max = (Po_max/Pi_max)*100;
10 Pq_max = (1/2)*(2*Vcc^2/((%pi^2)*Rl));
11
12 disp(Po_max, 'Maximum output power(Watts) = ');
13 disp(Pi_max, 'Maximum input power(Watts) = ');
14 disp(Pq_max, 'Transmission dissipation(Watts) = ');

```

Scilab code Exa 12.9 Efficiency calculation

```

1 clear; clc; close;
2
3 Vcc = 24;
4
5 //part a
6 Vl_p = 22;
7 n = 78.54*(Vl_p/Vcc);
8 disp(n, 'Efficiency(Percentage) = ');
9
10
11 //part b
12 Vl_p = 12;
13 n = 78.54*(Vl_p/Vcc);
14 disp(n, 'Efficiency(Percentage) = ');

```

Scilab code Exa 12.10 Input output dissipated power and efficiency

```

1 clear; clc; close;
2
3 Vi_rms = 12;
4 Rl = 4;
5 Vcc = 25;
6

```

```

7
8
9 Vi_p = sqrt(2)*Vi_rms;
10 Vl_p = Vi_p;
11 Po_ac = (Vl_p^2)/(2*Rl);
12 Il_p = Vl_p/Rl;
13 Idc = (2/%pi)*(Il_p);
14 Pi_dc = Vcc*Idc;
15 Pq = (Pi_dc-Po_ac)/2;
16
17 n = (Po_ac/Pi_dc)*100;
18
19 disp(Po_ac, 'Output power(Watts) = ');
20 disp(Pi_dc, 'Input power(Watts) = ');
21 disp(Pq, 'Power dissipated(Watts) = ');
22 disp(n, 'Efficiency(Percentage) = ');

```

Scilab code Exa 12.11 Dissipated power and efficiency

```

1 clear; clc; close;
2
3 Vcc =25;
4 Rl = 4;
5
6
7 Po_max = (Vcc^2)/(2*Rl);
8 Pi_max = (2*Vcc^2)/(%pi*Rl);
9 n_max = (Po_max/Pi_max)*100;
10 Vl_p = Vcc;
11 P2q = Pi_max-Po_max;
12
13
14 disp(Po_max, 'Output power(Watts) = ');
15 disp(Pi_max, 'Input power(Watts) = ');
16 disp(P2q, 'Power dissipated(Watts) = ');

```

```
17 disp(n_max, 'Efficiency (Percentage) = ');
```

Scilab code Exa 12.12 Max dissipated power and input voltage

```
1 clear; clc; close;
2
3 Vcc =25;
4 R1 = 4;
5 V1_p = Vcc;
6
7 P2q_max = (2*Vcc^2)/((%pi^2)*R1);
8 V1 = 0.636*V1_p;
9
10 disp(P2q_max, 'Maximum power dissipated (Watts) = ');
11 disp(V1, 'Input voltage at which this occurs (Volts) =
    ');
```

Scilab code Exa 12.13 Harmonic distortion components

```
1 clear; clc; close;
2
3 A1 = 2.5;
4 A2 = 0.25;
5 A3 = 0.1;
6 A4 = 0.05;
7
8 D2 = (abs(A2)/abs(A1))*100;
9 D3 = (abs(A3)/abs(A1))*100;
10 D4 = (abs(A4)/abs(A1))*100;
11
12
13 disp(D2, 'Second harmonic distortion (Percentage) = ');
    ;
```

```
14 disp(D3, 'Third harmonic distortion (Percentage) = ');
15 disp(D4, 'Fourth harmonic distortion (Percentage) = ');
    ;
```

Scilab code Exa 12.14 Total Harmonic distortion components

```
1 clear; clc; close;
2
3 D2 = 0.1;
4 D3 = 0.04;
5 D4 = 0.02;
6
7 THD = sqrt((D2^2)+(D3^2)+(D4^2))*100;
8
9 disp(THD, 'Total harmonic distortion (Percentage) = ');
    ;
```

Scilab code Exa 12.15 Second Harmonic distortion

```
1 clear; clc; close;
2
3 //part a
4 Vce_min = 1;
5 Vce_max = 22;
6 Vceq = 12;
7 D2 = abs(((1/2)*(Vce_max+Vce_min)-Vceq)/(Vce_max -
    Vce_min))*100;
8 disp(D2, 'Second harmonic distortion (Percentage) = ');
    ;
9
10 //part b
11 Vce_min = 4;
12 Vce_max = 20;
```

```

13 Vceq = 12;
14 D2 = abs(((1/2)*(Vce_max+Vce_min)-Vceq)/(Vce_max-
    Vce_min))*100;
15 disp(D2,'Second harmonic distortion(Percentage) = ')
    ;

```

Scilab code Exa 12.16 Total Harmonic distortion and fundamental and total power

```

1 clear; clc; close;
2
3 D2 = 0.1;
4 D3 = 0.02;
5 D4 = 0.01;
6 I1 = 4;
7 Rc = 8;
8
9 THD = sqrt((D2^2)+(D3^2)+(D4^2));
10 P1 = (I1^2)*Rc/2;
11 P = (1+THD^2)*P1;
12
13 disp(THD,'Total harmonic distortion = ');
14 disp(P1,'Fundamental power component(Watts) = ');
15 disp(P,'Total power(Watts) = ');

```

Scilab code Exa 12.17 Maximum dissipation

```

1 clear; clc; close;
2
3 Pd_temp0 = 80;
4 T1 = 100;
5 T0 = 25;
6 D = 0.5;

```



```
7
8
9 Pd_temp1 = Pd_temp0 - (T1 - T0) * (D);
10
11 disp(Pd_temp1, 'Maximum power dissipation (Watts) = ');
    ;
```

Scilab code Exa 12.18 Max dissipated power

```
1 clear; clc; close;
2
3 Tj = 200;
4 Ta = 40;
5 Qjc = 0.5;
6 Qcs = 0.6;
7 Qsa = 1.5;
8
9
10 Pd = (Tj - Ta) / (Qjc + Qcs + Qsa);
11
12 disp(Pd, 'Maximum power dissipated (Watts) = ');
```

Chapter 13

Linear Digital ICs

Scilab code Exa 13.1 frequency and output waveform

```
1 clear; clc; close;
2
3 Ra = 7.5*10^(3);
4 Rb = 7.5*10^(3);
5 C = 0.1*10^(-6);
6
7 Thigh = 0.7*(Ra+Rb)*C;
8 Tlow = 0.7*(Rb*C);
9 T = Thigh +Tlow;
10
11 f = 1/T;
12
13 disp(f, 'Frequency = ');
14
15
16 x = 0:0.001:1.575;
17 y = 5*(x<=1.05) + 1*(x>1.05);
18 plot2d(x,y);
19 a = gca();
```

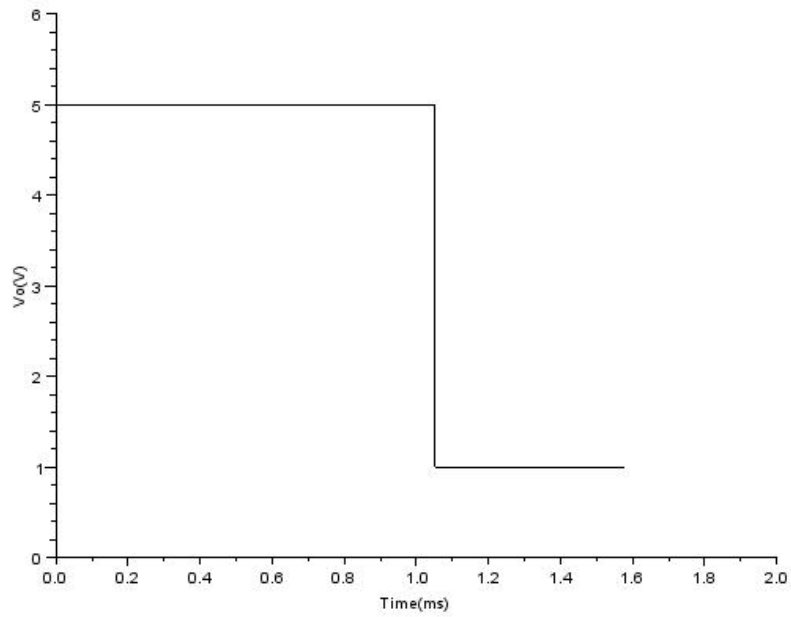

Figure 13.1: frequency and output waveform

```
20 a.data_bounds = [0 0;2 5.2];
21 a.x_label.text = 'Time(ms)';
22 a.y_label.text = 'Vo(V)';
```

Scilab code Exa 13.2 Period of output waveform

```
1 clear; clc; close;
2
3 Ra = 10*10^(3);
4 C = 0.1*10^(-6);
5
6 Thigh = 1.1*Ra*C;
7
8 disp(Thigh, 'Period of output waveform = ');
```

Chapter 14

Feedback and oscillator circuits

Scilab code Exa 14.1 input output impedance and voltage gain

```
1 clear; clc; close;
2
3 A = -100;
4 Zi = 10*10^(3);
5 Zo = 20*10^(3);
6
7
8 //part a
9 Beta = -0.1;
10 Af = A/(1+Beta*A);
11 Zif = Zi*(1+Beta*A);
12 Zof = Zo/(1+Beta*A);
13
14 disp(Af, 'Voltage gain for part a= ');
15 disp(Zif, 'Input impedance for part a= ');
16 disp(Zof, 'Output Impedance for part a= ');
17
18 //part b
19 Beta = -0.5;
20 Af = A/(1+Beta*A);
21 Zif = Zi*(1+Beta*A);
```

```

22 Zof = Zo/(1+Beta*A);
23
24 disp(Af, 'Voltage gain for part b = ');
25 disp(Zif, 'Input impedance for part b = ');
26 disp(Zof, 'Output Impedance for part b = ');

```

Scilab code Exa 14.2 change in gain of feedback amplifier

```

1 clear; clc; close;
2
3 Beta = -0.1;
4 dA_A = 20;
5 A = -1000;
6
7 dAf_Af = abs(1/(Beta*A))*abs((dA_A));
8 disp(dAf_Af, 'Percentage Change in gain of feedback
   amplifier = ');

```

Scilab code Exa 14.3 gain with and without feedback

```

1 clear; clc; close;
2
3 R1 = 80*10^(3);
4 R2 = 20*10^(3);
5 Ro = 10*10^(3);
6 Rd = 10*10^(3);
7 gm = 4000*10^(-6);
8
9
10 Rl = Ro*Rd/(Ro+Rd);
11 A = -gm*Rl;
12 Beta = -R2/(R1+R2);
13 Af = A/(1+Beta*A);

```

```
14
15 disp(A, 'Gain without feedback = ');
16 disp(Af, 'Gain with feedback = ');
```

Scilab code Exa 14.4 amplifier gain

```
1 clear; clc; close;
2
3 R1 = 1.8*10^(3);
4 R2 = 200;
5 A = 100000;
6
7
8 Beta = R2/(R1+R2);
9 Af = A/(1+Beta*A);
10 Af = 1/Beta;
11
12 disp(Af, 'Amplifier gain = ');
```

Scilab code Exa 14.5 voltage gain

```
1 clear; clc; close;
2
3 hfe = 120;
4 hie = 900;
5 Re = 510;
6 Rc = 2.2*10^(3);
7 re = 7.5;
8
9 A = -hfe/(hie+Re);
10 Beta = -Re;
11 Af = A/(1+Beta*A);
12 Avf = Af*Rc;
```

```
13 Av = -Rc/re;  
14  
15  
16 disp(Avf, 'Voltage gain with feedback = ');  
17 disp(Av, 'Voltage gain without feedback = ');
```

Scilab code Exa 14.6 voltage gain

```
1 clear; clc; close;  
2  
3 gm = 5*10(-3);  
4 Rd = 5.1*10(3);  
5 Rs = 1*10(3);  
6 Rf = 10*10(3);  
7  
8  
9 Av = -gm*Rd;  
10 Avf = (-gm*Rd)*(Rf/(Rf+(gm*Rd*Rs)));  
11  
12 disp(Av, 'Voltage gain without feedback = ');  
13 disp(Avf, 'Voltage gain with feedback = ');
```

Scilab code Exa 14.7 value of C

```
1 clear; clc; close;  
2  
3 R = 10*10(3);  
4 f = 5*10(3);  
5 A = 40;  
6 gm = 5000*10(-6);  
7  
8 C = 1/(2*%pi*R*f*sqrt(6));  
9 Rl = abs(A)/gm;
```



```
10
11 disp(C, 'Value of C = ');
12 disp(Rl, 'Value of Rl = ');
```

Scilab code Exa 14.8 resonant frequency and RC elements

```
1 clear; clc; close;
2
3 R = 51*10^(3);
4 C = 0.001*10^(-6);
5
6
7 fo = 1/(2*%pi*R*C);
8
9 disp(fo, 'Resonant frequency = ');
10
11 fo2 = 2*fo;
12 RC = 1/(2*%pi*fo2);
13 R = 50*10^(3);
14 C = 510*10^(-12);
15
16 disp(R, 'Value of R can be = ');
17 disp(C, 'Value of C can be = ');
```

Scilab code Exa 14.9 RC elements for wien bridge

```
1 clear; clc; close;
2
3 fo = 5*10^(3);
4
5 R = 50*10^(3);
6 C = 1/(2*%pi*fo*R);
7
```

```
8 disp(R, 'Value of R can be = ');  
9 disp(C, 'Value of C is = ');
```

Chapter 15

Power Supplies

Scilab code Exa 15.1 Measure output and filter voltage

```
1 clear; clc; close;
2
3 Vdc = 25;
4 Vr = 1.5;
5
6
7 r_a = (Vr/Vdc)*100;
8 r_b = (Vr*0.35/Vdc)*100;
9
10 disp(r_a, 'Ripple value in part a = ');
11 disp(r_b, 'New Ripple value in part b = ');
```

Scilab code Exa 15.2 Voltage regulation value

```
1 clear; clc; close;
2
3 Vn1 = 60;
4 Vf1 = 56;
```

```
5
6 VR = ((Vn1-Vf1)/Vf1)*100;
7
8 disp(VR, 'Voltage regulation in percentage = ');
```

Scilab code Exa 15.3 Ripple voltage and output voltage value

```
1 clear; clc; close;
2
3 //part a
4 Idc = 50*10(-3);
5 C = 100*10(-6);
6
7 Vr_rms = 2.4*(10(-3))*Idc/(C);
8
9 disp(Vr_rms, 'Ripple voltage = ');
10
11 //part b
12
13 Rl = 100;
14
15 Vdc = Vr_rms*Rl*C/2.4;
16
17 disp(Vdc, 'Output voltage = ');
```

Scilab code Exa 15.4 Filter dc voltage value

```
1 clear; clc; close;
2
3 Vm = 30;
4 Idc = 50;
5 C = 100;
6
```

```
7 Vdc = Vm - 4.17*Idc/C;
8
9 disp(Vdc, 'Filter dc voltage = ');
```

Scilab code Exa 15.5 Ripple of capacitor

```
1 clear; clc; close;
2
3 Idc = 50;
4 C = 100;
5 Vdc = 27.9;
6
7 r = (2.4*Idc/(C*Vdc))*100;
8
9 disp(r, 'Ripple value of capacitor in percentage = ');
;
```

Scilab code Exa 15.6 dc voltage across 1k load

```
1 clear; clc; close;
2
3 R1 = 1000;
4 R = 120;
5 Vdc = 60;
6
7 Vdc_dash = (R1/(R+R1))*Vdc;
8
9 disp(Vdc_dash, 'Dc voltage across 1k-ohm load = ');
```

Scilab code Exa 15.7 dc ac and ripple values of output signal

```

1 clear; clc; close;
2
3 Rl = 5*10^(3);
4 R = 500;
5 Vdc = 150;
6 C = 10*10^(-3);
7 Vr_rms = 15;
8
9 Vdc_dash = (Rl/(R+Rl))*Vdc;
10 Xc = 1.3/C;
11 Vr_rms_dash = (Xc/R)*Vr_rms;
12 r = (Vr_rms_dash/Vdc_dash)*100;
13
14 disp(Vdc_dash, 'Dc component of output voltage = ');
15 disp(Vr_rms_dash, 'Ac component of output voltage = '
    );
16 disp(r, 'Ripple = ');

```

Scilab code Exa 15.8 output voltage and zener current

```

1 clear; clc; close;
2
3 Vz = 12;
4 Vbe = 0.7;
5 Vi = 20;
6 Rl = 5*10^(3);
7 Ic = 2.26*10^(-3);
8 Beta = 50;
9 R = 220;
10
11 Vo = Vz-Vbe;
12 Vce = Vi-Vo;
13 Ir = (Vi-Vz)/R;
14 Il = Vo/Rl;
15 Ib = Ic/Beta;

```

```
16 Iz = Ir-Ib;
17
18 disp(Vo, 'Output voltage = ');
19 disp(Iz, 'Zener current = ');
```

Scilab code Exa 15.9 regulated output voltage

```
1 clear; clc; close;
2
3 R1 = 20*10^(3);
4 R2 = 30*10^(3);
5 Vz = 8.3;
6 Vbe = 0.7;
7
8 Vo = ((R1+R2)/R2)*(Vz+Vbe);
9
10 disp(Vo, 'Regulated Output voltage = ');
```

Scilab code Exa 15.10 regulated output voltage

```
1 clear; clc; close;
2
3 Vo = (1+( 30*10^(3)/(15*10^(3)) ))*6.2;
4
5 disp(Vo, 'Regulated Output voltage = ');
```

Scilab code Exa 15.11 regulated voltage and circuit current

```
1 clear; clc; close;
2
```

```

3 R1 = 320;
4 Vi = 22;
5 Rs = 120;
6
7
8 V1 = 8.2+0.7;
9 I1 = V1/R1;
10 Is = (Vi-V1)/Rs;
11 Ic = Is-I1;
12
13 disp(V1, 'V1 = ');
14 disp(I1, 'I1 = ');
15 disp(Is, 'Is = ');
16 disp(Ic, 'Ic = ');

```

Scilab code Exa 15.13 minimum input voltage

```

1 clear; clc; close;
2
3 Idc = 400*10^(-3);
4 C = 250*10^(-6);
5 Vm = 15;
6 Vdc = 15;
7
8 Vr_peak = sqrt(3)*2.4*(10^-3)*Idc/C;
9 Vi = Vdc - Vr_peak;
10
11 disp(Vi, 'Minimum input voltage = ');

```

Scilab code Exa 15.14 max value of load current

```

1 clear; clc; close;
2

```



```

3 Vm = 15;
4 Vi_min = 7.3;
5 C = 250*10(-6);
6
7 Vr_peak = Vm - Vi_min;
8 Vr_rms = Vr_peak/sqrt(3);
9
10 Idc = Vr_rms*C/(2.4*(10-3));
11
12 disp(Idc, 'Max value of load current = ');

```

Scilab code Exa 15.15 regulated output voltage

```

1 clear; clc; close;
2
3 Vo = 1.25*(1+ (1.8*103/240)) + (100*10(-6))
      *(1.8*103);
4
5 disp(Vo, 'Regulated Output voltage = ');

```

Scilab code Exa 15.16 regulated output voltage

```

1 clear; clc; close;
2
3 Vo = 1.25*(1+ (1.8*103/240)) + (100*10(-6))
      *(1.8*103);
4
5 disp(Vo, 'Regulated Output voltage = ');

```
